

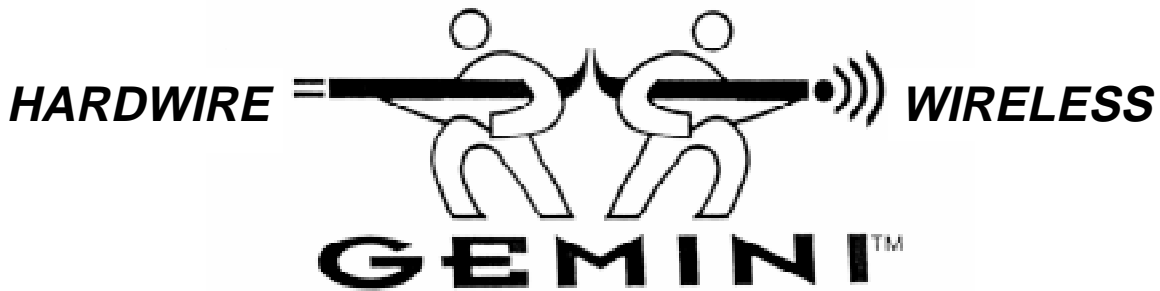

PROGRAMMING INSTRUCTIONS



GEM-P1632 CONTROL PANEL/COMMUNICATOR

Quick Start:

1. Refer to the wiring diagram, connect siren, aux. power, pgm. output, remote bus, earth ground, zone and telephone wiring. NOTE: See Installation Instructions (WI808).
2. Connect AC power first and then the battery.
3. Configure the keypad (see page 40).
4. Access the Easy Menu Driven (Dealer Program) Mode:

Press **4** **5** **6** **7F** **8A** **9P** **FUNCTION**

↙ Dealer Code ↘

Press **INSTANT** Until "ACTIVATE PROGRAM Y/N" (GEM-RP1CAe2) or "TURN ON PROG Y/N" (GEM-RP2ASe2) appears on LCD screen.

Press **INSTANT** To Enter Dealer Program Mode (see page 6).

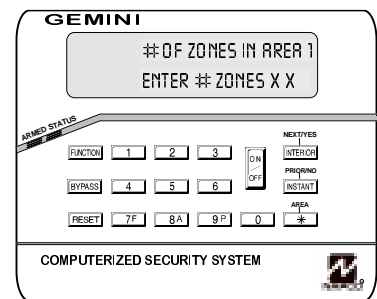

GEM-RP1CAe2 Keypad

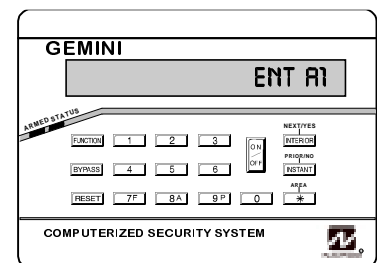

GEM-RP2ASe2 Keypad



NAPCO Security Systems, Inc.

333 Bayview Avenue, Amityville, New York 11701

For Sales and Repairs, call toll free: (800) 645-9445

For direct line to Technical Service, call toll free: (800) 645-9440

Internet: <http://www.napcosecurity.com>

TABLE OF CONTENTS

SYSTEM PROGRAMMING OPTIONS.....	4	<i>Keypad Programming Overview</i>	<i>17</i>
<i>Introduction</i>	<i>4</i>	<i>Accessing Direct Address Program Mode</i>	<i>17</i>
<i>Downloading from a Computer</i>	<i>4</i>	<i>What You See on the Keypad.....</i>	<i>17</i>
EASY MENU DRIVEN PROGRAM MODE.....	5	<i>Direct Address Program Mode Keypad Commands</i>	<i>18</i>
<i>Dealer Program - Preliminary Information.....</i>	<i>5</i>	<i>Programming Overview</i>	<i>19</i>
<i>Accessing Dealer Program Mode</i>	<i>5</i>	<i>Direct Address Programming Example.....</i>	<i>20</i>
<i>Customizing a Default Program</i>	<i>5</i>	PROGRAMMING OPTIONS & WORKSHEETS	21
GEM-RP1CAe2 KEYPAD	6	<i>System Delays & Timeouts (Addr 0000-0002)</i>	<i>22</i>
<i>Number of Zones in Area 1.....</i>	<i>6</i>	<i>System Delays & Timeouts (Addr 0711, 0715-0717)...</i>	<i>22</i>
<i>Panel Zone Doubling</i>	<i>6</i>	<i>System Output Timeouts (Addr 0710, 0712-0714)</i>	<i>23</i>
<i>Fire Zones in Area 1</i>	<i>6</i>	<i>Download/Callback Opt. (Addr 1183, 0236-0255)</i>	<i>23</i>
<i>2-Wire Fire Zones in Area 1.....</i>	<i>6</i>	<i>Pager Format Options (Addr 0256 & 0257)</i>	<i>23</i>
<i>Local or Central Station Reporting System.....</i>	<i>6</i>	<i>Syst. Opt. & Ambush Code (Addr 0460-0485 & 1054) 24</i>	
<i>Exit/Entry Zones in Area 1</i>	<i>7</i>	<i>System Options (Addr 0718-0722)</i>	<i>25</i>
<i>Interior zones in Area 1</i>	<i>7</i>	<i>CS Receiver Opt. (Addr 0170-0191, 0192-0213).....</i>	<i>26</i>
<i>Number of Keypads in Area 1.....</i>	<i>7</i>	<i>CS Receiver Opt. (Addr 0214-0235).....</i>	<i>26</i>
<i>Central Station Receiver 1 Tel. Number</i>	<i>7</i>	<i>CS Subscriber Reporting Opt. (Addr 0259-0347)</i>	<i>27</i>
<i>Central Station Receiver 1 Account Number</i>	<i>7</i>	<i>CS Zn Reporting Opt. (Addr 0358-0389 & 0391-0394) 28</i>	
<i>Central Station Receiver 1 Format.....</i>	<i>8</i>	<i>CS User Reporting Opt. (Addr 0440-0459).....</i>	<i>29</i>
<i>Enter User Codes</i>	<i>8</i>	<i>EZM Group & Area Options (Addr 0737-0749).....</i>	<i>30</i>
<i>RF Transmitter Points.....</i>	<i>9</i>	<i>Keypad Options (Addr 0723-0736)</i>	<i>31</i>
<i>Key Fob Transmitters</i>	<i>10</i>	<i>Zones 1-16 Options (Addr 0490-0592)</i>	<i>32</i>
<i>Enter Zone Descriptions</i>	<i>10</i>	<i>Zones 17-32 Options (Addr 0601-0702)</i>	<i>33</i>
<i>Dealer Code.....</i>	<i>10</i>	<i>RF Rcvrs. & Sup. Timers (Addr 1038-1053 & 1180)....</i>	<i>34</i>
GEM-RP2ASe2 KEYPAD	11	<i>External Relay Control (Addr 0750-0829).....</i>	<i>35</i>
<i>Number of Zones in Area 1.....</i>	<i>11</i>	<i>System Reset Features (Addr 1197 & 1198).....</i>	<i>37</i>
<i>Panel Zone Doubling</i>	<i>11</i>	USER PROGRAM MODE.....	38
<i>Fire Zones in Area 1</i>	<i>11</i>	<i>Preliminary Information</i>	<i>38</i>
<i>2-Wire Fire Zones in Area</i>	<i>12</i>	<i>Accessing User Program Mode</i>	<i>38</i>
<i>Local or Central Station Reporting System.....</i>	<i>12</i>	<i>User Codes</i>	<i>38</i>
<i>Exit/Entry Zones in Area 1</i>	<i>12</i>	<i>Zone Descriptions</i>	<i>39</i>
<i>Interior zones in Area 1.....</i>	<i>12</i>	KEYPAD CONFIGURATION MODE	40
<i>Number of Keypads in Area 1.....</i>	<i>13</i>	<i>Keypad Installation.....</i>	<i>40</i>
<i>Central Station Receiver 1 Tel. Number</i>	<i>13</i>	<i>Configuring the Keypads.....</i>	<i>40</i>
<i>Central Station Receiver 1 Account Number</i>	<i>13</i>	GEM-P1632 EASY MENU PROG. WORKSHEETS	43
<i>Central Station Receiver 1 Format.....</i>	<i>13</i>	PROGRAMMING OPTIONS INDEX.....	46
<i>Enter User Codes</i>	<i>14</i>	GLOSSARY	48
<i>RF Transmitter Points.....</i>	<i>15</i>	KEYPAD PROGRAMMING MODES.....	64
<i>Key Fob Transmitters</i>	<i>16</i>	GEM-P1632 WIRING DIAGRAM.....	68
<i>Dealer Code.....</i>	<i>16</i>		
DIRECT ADDRESS PROGRAM MODE.....	17		

Refer to accompanying GEM-P1632 Installation Instructions (WI808) for installation information.

NOTE: THESE PROGRAMMING INSTRUCTIONS ARE INTENDED AND WRITTEN FOR THE PROFESSIONAL INSTALLER HAVING SUITABLE EXPERIENCE AND INSTALLATION EQUIPMENT. THE UNIT IS DESIGNED TO BE PROGRAMMED USING AN IBM-COMPATIBLE COMPUTER WITH NAPCO PCD3000 SOFTWARE. AFTER PROGRAMMING, BE SURE TO RUN THE PCD3000 ERROR-CHECK UTILITY TO GUARD AGAINST PROGRAMMING CONFLICTS FOR THE TYPE OF SERVICE SELECTED FOR THE INSTALLATION.



SYSTEM PROGRAMMING OPTIONS

INTRODUCTION

The GEM-P1632 control panel may be programmed by various means, each of which will be covered in detail in the sections that follow. Keypad displays shown first are for a GEM-RP1CAe2, the recommended keypad for programming, then for the GEM-RP2ASe2. The GEM-RP2ASe2 keypad functions similarly; however, because of its reduced display capabilities, messages are abbreviated and will scroll through two or more screens. Zone descriptions cannot be programmed using a GEM-RP2ASe2 keypad.

- ✓ **Downloading From a Computer.** This is the preferred method. The panel may be downloaded from (or uploaded to) an IBM PC-compatible computer, with a 386 (or higher) microprocessor, either locally or remotely. Napco's PCD3000 Quickloader software, Version Update 3.26 or later features context-sensitive help screens as well as an error-checking utility that prevents programming of incompatible or conflicting data to ensure proper panel operation.
- ✓ **Easy Menu Driven Program (Dealer Program) Mode - Keypad Programming.** The Easy Menu Driven Program Mode allows keypad programming of number of zones in area 1, zone doubling, number of fire zones (both 4-wire and 2-wire), central station reporting, number of entry/exit zones, number of interior zones, number of keypads in area 1, central station telephone number, central station account number, central station receiver format, user codes, rf transmitter points, rf key fob transmitters and zone descriptions. For new panels, a custom default program may be created at the keypad. A menu-driven utility prompts the installer to configure the system. Further, detailed customization is done in the Direct Address Program Mode.
- ✓ **Direct Address (Dealer Program) Program Mode - Keypad Programming.** The Direct Address Program Mode is an extension of the Dealer Program Mode wherein data is entered at the keypad by location. This mode is accessed from the Easy Menu Driven Program Mode by pressing the **[RESET]** button at any time.
- ✓ **User Program Mode - Keypad programming.** The User Program Mode is intended for authorized users and is limited to keypad programming of User Codes and Zone Descriptions.

DOWNLOADING FROM A COMPUTER

The control-panel program may be downloaded from the computer by either of the following methods.



peripheral devices are con-

Local Downloading

(Note: This procedure should be used prior to installation, before connected.)

For a direct high-speed data transfer to the control panel from a desktop computer, connect the download jack (JP2) on the panel to the LOCAL jack (J3) on the Napco PCI2000/3000 computer interface using the supplied 6-conductor cable. (Refer to PCI2000/3000 Installation Instructions WI443 for wiring diagram and procedures.)

Similarly, a high-speed local download may be made in the field using a notebook or laptop computer. Connect JP2 on the control panel to a Napco PCI-MINI computer interface using the 6-conductor cable supplied. (Refer to PCI-MINI Installation Instructions WI767.)

Remote Downloading

(Also see PCI2000/3000 Installation Instructions WI443.)

Function Mode. During this procedure, voice contact will be lost, therefore both the installer and the computer operator should be familiar with the operation. When a steady high-pitched tone is heard at the site phone, access the "ACTIVATE DOWNLOAD" Function (see Keypad Programming Modes), then press the **[ON/OFF]** button or the YES (**[INTERIOR]**) button; the site phone will go dead. Hang up the phone and wait for a call from the central station confirming a successful download.

Callback Method. An installed, unattended panel may be programmed or reprogrammed remotely using the Callback-Method Download feature of the PCD3000 software. Remote downloading requires a modem compatible with the PCI2000/3000. Upon answering the call from the computer, the panel will verify the Download Security Code and, if confirmed, will establish a connection. If a Callback Number is programmed into the panel, the panel will automatically disconnect and call the computer at this number before establishing a connection.

EASY MENU DRIVEN PROGRAM MODE

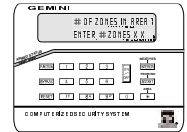

DEALER PROGRAM - PRELIMINARY INFORMATION

- ☞ Only Keypad #1 may be used for both dealer and user programming, however this keypad may be located in any area.
- ☞ The Default Dealer Code is **4 5 6 7F 8A 9P**. Use this code to enter the Dealer Program Mode to program a custom Dealer Code, which replaces the Default Dealer Code. If you clear your Dealer Code, use the Default Dealer Code once again to enter programming.
- ☞ After entering codes or data, press the save  button. Data will not be stored into memory unless it is pressed.
- ☞ If the keypad is in the Program Mode and no activity is detected for longer than 4 minutes, a steady tone will sound. Silence the sounder by the ***** button to continue, or by pressing the **RESET** button to exit.
- ☞ A panel that has been SYSTEM RESET performs identically to a new panel.
- ☞ When programming a Multiple Area System, Direct Address Programming Mode must be used to complete the program.

KEYPAD #1: For ease of programming, it is recommended that a GEM-RP1CAe2 be used as Keypad #1. (Regardless of which keypad is selected, all *new* keypads are configured as Keypad #1 out of the box.)

If a GEM-RP2ASe2 is used, configure address jumpers as Keypad #1 (see Configuring the GEM-RP2ASe2 Keypad.). Use the **FUNCTION** button to manually scroll through each selected option and at the end of each programming line.

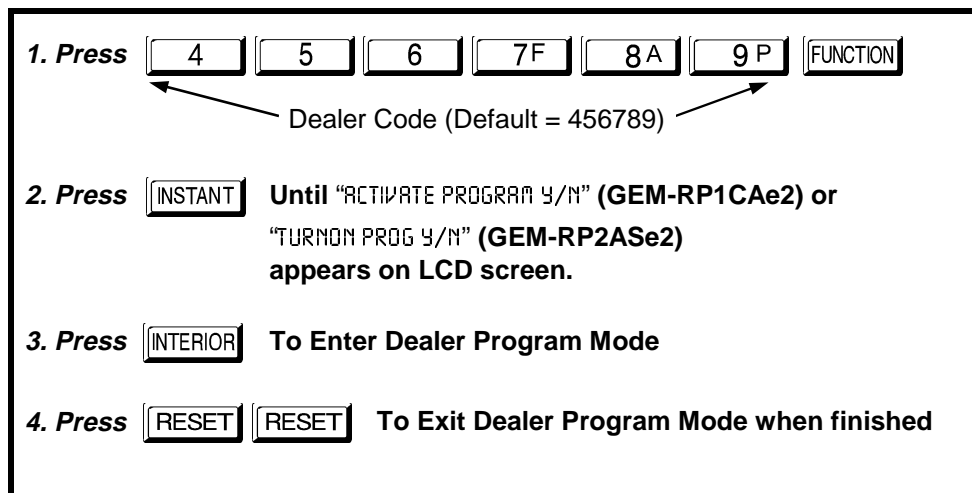

ACCESSING DEALER PROGRAM MODE CUSTOMIZING A DEFAULT PROGRAM

- | | | |
|--------------------------------------|----------------------------------|---|
| ✓ Number of Zones in Area 1 | ✓ Interior Zones in Area 1 | ✓ RF Transmitter Points |
| ✓ Panel Zone Doubling | ✓ Number of Keypads in Area 1 | ✓ Key Fob Transmitters |
| ✓ Fire Zones in Area 1 | ✓ CS Receiver 1 Telephone Number | ✓ Zone Descriptions (GEM-RP1CAe2 Keypad Only) |
| ✓ 2-Wire Fire Zones in Area 1 | ✓ CS Receiver 1 Account Number | ✓ Dealer Code |
| ✓ Local or Central station Reporting | ✓ CS Receiver 1 Format | |
| ✓ Exit/Entry Zones in Area 1 | ✓ User Codes | |

For any new panel, you can design a default program that will best suit your application. Using this procedure, you will configure the panel for:

NEW PANELS: The custom default program may be created for new panels only. Once the panel has been programmed by any means, the number of areas, zones and keypads will be suppressed and cannot be changed. Should it be necessary to create a new custom default program, (a) from the Dealer Program Mode, press the **RESET** button to enter the Direct Address Program Mode; (b) access Location 1197 (Clear Program); (c) press the  button and start over.



A. GEM-RP1CAe2 Keypad

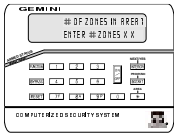

To create your customized default program using a GEM-RP1CAe2 keypad, enter the following parameters and record your information on the *Easy Menu Programming Worksheet* (see page 43). In each of the following steps, press the **FUNCTION** button to set cursor, the **NEXT (INTERIOR)** button to go forwards, the **PRIOR (INSTANT)** button to go backwards, the **ON/OFF** button to save and the **RESET** button twice to exit at any time.

#OF ZNS IN AREA1
ENTER # ZONES _ _

(Direct Entry)

Total Number of Zones in Area 1 (Appears for New Panel Only)

Directly enter the total number of zones to be programmed for Area 1. Valid entries are from 01 to 32. Directly enter the total number of zones, including leading zeros. Use number buttons **1** through **9P**. **NOTE:** Press the **0** button for a zero. The system is based on groups of 4 zones each

(after the first 8 zones), and will automatically round up to the next group of 4. For example, if you enter 18, it will automatically convert this to 20 zones. Press **ON/OFF** to save. Press **NEXT (INTERIOR)** button to proceed. **NOTE:** If you are programming a 2 Area system, enter the total number of zones required for Areas 1 & 2. The Direct Address Program Mode can then be used to remove zones from Area 1 and place them in Area 2. See Zone Options. If Programming a Wireless Only system, or using wireless only on Zones 9-32, enter the total number of zones in system. Enter the transmitter points in the RF Transmitter section of the Easy Menu Driven Programming Mode.

EZ ZONE DOUBLING
ENABLED? Y/N

(Press YES or NO)

Panel Zone Doubling (Appears for New Panel Only)

If you wish to double the number of hardwired zones within the panel from 8 to 16, press the **YES (INTERIOR)** button. The 16 zones will no longer be EOL zones, but will be designated for Normally Closed devices only. The terminal for Zone 1 will now support both Zones 1 and 9 with the use of the supplied EZ Zone Doubling™ resistors, E (2.2K) & Z (3.9K) supplied. (Refer to Wiring

Diagram and Installation Instructions). If Panel Zone doubling is not desired, press **NO (INTERIOR)**.

FIRE ZONES
ENTER ZONE # _ _

(Direct Entry)

Fire Zones in Area 1 (Appears for New Panel Only)

Enter the number of any zones which are to be used as Fire Zones (both 2-wire, 4-wire or wireless). Valid entries are from 01 to 32. Directly enter each zone number, including leading zeros, and press **ON/OFF** to save, and then repeat for any additional zone(s). Press **NEXT (INTERIOR)** button to proceed.

NOTE: If you are programming a 2 Area system, enter the total number of zones required for Areas 1 & 2. The Direct Address Program Mode can then be used to remove zones from Area 1 and place them in Area 2. See Zone Options.

2-WIRE FIRE ZNS
ENTER ZONE # _ _

(Direct Entry)

2-Wire Fire Zones in Area 1 (Appears for New Panel Only)

Enter the number of any Fire Zones (from previous question) which are to be used with 2-wire smoke detectors. The only valid entries are 07 and 08. Directly enter each zone number, including leading zeros. Press **ON/OFF** to save,

and then repeat for any additional zone(s). **NOTE:** Only zones which have been designated as Fire Zones may be programmed as 2 Wire Fire zones. Press **NEXT (INTERIOR)** button to proceed. **NOTE:** JP3 must be set to "2-WF" position for 2-wire fire zones (refer to Installation Instructions).

REPORT ALL ZONES
TO CENTRAL? Y/N

(Press YES or NO)



Local or Central Station Reporting System (Appears for New Panel Only)



Press **YES (INTERIOR)** button for all zones to report; press **NO (INSTANT)** button for no zones to report (LOCAL SYSTEM).

ENTRY/EXIT ZONES
ENTER ZONE # _ _

(Direct Entry)

Entry/Exit Zones in Area 1 *(Appears for New Panel Only)*

Directly enter the zone number of any zones which are to be used as Entry/Exit zones. Valid entries are from 01 to 32. Directly enter each zone number, including leading zeros. Use number buttons  through .

NOTE: Press the  button for a zero. Press  to save and then repeat



for any additional zone(s). Press NEXT () button to proceed.

NOTE: Chime will automatically be programmed for all E/E zones. If you are programming a 2 Area system, enter the total number of zones required for Areas 1 & 2. The Direct Address Program Mode can then be used to remove zone from Area 1 and place them in Area 2. See Zone Options.

INTERIOR ZONES
ENTER ZONE # _ _

(Direct Entry)

Interior Zones in Area 1 *(Appears for New Panel Only)*

Directly enter the zone number of any zones which are to be used as Interior Zones. Valid entries are from 01 to 32. Directly enter each zone number, including leading zeros. Use number buttons  through .

NOTE: Press the  button for a zero. Press  to save and then repeat for any



additional zone(s). Press NEXT () button to proceed.



NOTE: All Interior zones will also be automatically programmed as "Exit/Entry Follower" zones. If you are programming a 2 Area system, enter the total number of zones required for Areas 1 & 2. The Direct Address Program Mode can then be used to remove zones from Area 1 and place them in Area 2. See Zone Options.

AREA 1 KEYPADS
ENTER #KPS _ _

(Direct Entry)

Number of Keypads in Area 1

Directly enter the total number of Keypads to be installed in Area 1. Valid entries are from 01 to 07. Directly enter the number of keypads, including leading zeros. Use number buttons  through .

NOTE: Press the  button for a zero. Press  to save. Press NEXT () button to proceed.









NOTE: Area 2 keypads can only be assigned in Direct Address

Programming. See Keypad Options.



CENTRAL PHONE #
_ _ _ _ _

(Direct Entry)

Central Station Receiver 1 Telephone Number

Using number buttons, enter telephone number of up to 16 digits including prefix letters, if necessary, for receiver 1. Use number buttons  through  for digits 1–9; press the   button for a zero and   through   for letters B–F, respectively.

NOTE:







Pre-Dial Delay = "D"; Dial-Tone Detection = "E". Pressing the  button will produce a blank space (•). Press  to save. Press NEXT () button to proceed.

NOTE: Central Station Receiver 2 and 3 Telephone Numbers can only be entered in Direct Address Programming. See CS Receiver Options.

CENTRAL STATION
ACCOUNT #

(Direct Entry)

Central Station Receiver 1 Account Number

Enter an account number of up to four digits. Use number buttons  through  for digits 1–9. **NOTE:** Press the  button for a zero and press   button for a blank space (•). Press  to save. Press NEXT () button to proceed.

NOTE: Central Station Receiver 2 and 3 Account Numbers can only be entered in Direct Address Programming. See CS Reporting Options.

SEE WI FOR INFO
RCVR FORMAT {0}

(Direct Entry)

Central Station Receiver 1 Format

From the table below, enter the central station's receiver format. Use number buttons [1] through [9P]. **NOTE:** Press the [0] button for a zero. and press [*] [0] for a blank space (•). Press [*] [1] through [*] [4] for letters B–E, respectively.

Press [ON/OFF] to save. Press NEXT ([INTERIOR]) button to proceed.

DATA ENTRY	CS RECEIVER 1 FORMAT
•(blank)	Ademco Slow, Silent Knight Slow
2	Radionics Fast
3	Silent Knight Fast
4	Radionics, DCI, Franklin Slow

DATA ENTRY	CS RECEIVER 1 FORMAT
5	Universal High Speed
B	SIA
C	Ademco Point ID
E	Pager

NOTE: Central Station Receiver 2 and 3 Formats can only be entered in Direct Address Programming. See CS Receiver Options.

ENTER USER CODE
U01 123 _ _ - 1 - _ _

User# User Code Area 1 Area 2

Enter User Codes (Press the ([FUNCTION]) button to set cursor.)

For default program, enter up to 32 User Codes, with Area 1 and Area 2 Options.

Press the ([FUNCTION]) button once to set the cursor to the User Code. Use the number buttons [1] through [9P] to enter a code of up to 6 digits. Enter up to 6 digits (4 digits is recommended) in the first six boxes entries are: 0-9. **NOTE:** Press the [0] button for a zero. No blank spaces in between; leave blank (•) any trailing boxes. If "Enable Global Ambush Code" (Address 0720) is enabled and left blank(•), do not program the first two digits of ANY User Code as '99'.

from left to right for each user code. Valid spaces in between; leave blank (•) any trailing "Global Ambush Code" (Address 1054) is

If the programmed code was less than 6 digits, press the ([FUNCTION]) button once to set the cursor to the Area 1 Options Level. Refer to the table below for the available area options.

USER OPTIONS		
USER CODE (UP TO 6 DIGITS)	AREA 1 OPTIONS	AREA 2 OPTIONS

USER AREA OPTIONS		
DATA ENTRIES	OPTION ENABLED	
L	R	
blank(•)	blank(•)	Disabled
blank(•)	1	Arm/Disarm
blank(•)	2	Arm Only
blank(•)	3	Service
blank(•)	4	Access
blank(•)	Add 8	* User Program

AREA OPTIONS: Up to 32 User Codes may be programmed.

Select the desired Area Options (Area 1 and Area 2) from the table shown and enter in the remaining four boxes for each user code.

Example: Program a code of "2222" for user 02, with area 1 options of "Arm/Disarm" and "User Program". Enter "2222" for a user code, "•(blank) 9" for area 1 options and "•(blank) •(blank)" for area 2 options.

AREA OPTIONS	EXPLANATION
Disabled	User Code not active in this area.
Arm/Disarm	Allows User Code to arm/disarm this area.
Arm Only	Prevents User Code from disarming this area.
Service	A Service Code has restricted arm/disarm rights; if an area is armed with a Service Code, a "SERVICE ON" appears on the GEM-RP1CAe2 keypad (a "5" on the GEM-RP2ASe2 keypad) and the area can be disarmed with any valid User Code, including a Service Code. If the area is armed with OTHER than a Service Code, it CANNOT be disarmed with a Service Code. This is typically used to allow tradesmen access to premises under control of the owner.
Access	This is normally used to activate a door striker while an area is disarmed. Also program "Access Control on PGM2 Output" (Address 0719) and "PGM2 Output Access Control Timeout" (Address 0711).
* User Program	User Program Option is enabled for Keypad 1 only, wherever it is connected (Area 1 or Area 2). To enable User Program Option for any user add 8 to the data entry for Area Option (see example). Then, User Programming can be performed only at Keypad 1 by a user code with user program enabled.

For Area 2 Options, press the ([FUNCTION]) button once again. Refer to the table above for available options. **NOTE:** Press the [*] [0] for blank space (•).

Press [ON/OFF] to save. To proceed to the next User Code, press the ([FUNCTION]) button to set the cursor to the User Number and change it using the number buttons.

Program a new User Code as previously described. Remember to record your user codes in the *Easy Menu Programming Worksheet* at the back of this manual.

Related User Options: "Enable Global Ambush Code" (Address 0720), "Global Ambush Code" (Address 1054) & "Enable Managers Mode" (Address 0719).

CHANGING OR CANCELING A CODE: To change any code, merely program over the existing code as described above and press [ON/OFF] to save. Similarly, to cancel a code, blank out each number of the code press [ON/OFF] to save.



EASY MENU DRIVEN PROGRAM MODE

```

ZN# XMIT# +CS P
ZN01-000000: 0- 0

```

Zone # Mapped to	Xmitter ID	Check Sum	Point #

ID Code number, "A" = ; "B" = ; "C" = ; "D" = ; "E" = ; "F" = . Press  to save. Press NEXT () button to proceed.

```

ZN# XMIT# +CS P
ZN01-000000: 0- 0

```

```

ZN# XMIT# +CS P
ZN01-ENROLL:A--

```

RF Transmitter Points (Press the () button to set cursor.)

(For wireless systems only. Also see Quick Method, which follows)

For each transmitter (key fob transmitters also), enter the zone number (01–32) to which the transmitter will be mapped, the 6-digit RF ID #:1-digit checksum number printed on the transmitter and box, the number of points (1–4); enter "9" for unsupervised (all points). **NOTE:** When programming the

Quick Method. If a receiver is already installed in the panel, Napco transmitter wireless points can be programmed automatically ("enrolled") using the following procedure. **NOTE:** The transmitter point will be enrolled only if the signal strength is 3 or greater.

1. Enter the zone number to which the transmitter point will be mapped.

2. Press the () button to enter the Enroll Mode. The red and green LEDs on the keypad will flash and the window will display as shown at left.

3. Open the loop of the point that is to be programmed (GEM-TRANS2 or GEM-TRANS4 only).

4. Install the transmitter battery. The keypad will beep to indicate that the point has been successfully enrolled. Multi-point transmitters can be mapped to successive zones simultaneously (Example 1) or to selected zones point by point (Example 2).

Example 1. A 4-point transmitter has the RF ID number 410078:1. Map the first three points to Zones 11–13, respectively.

1. Enter the Enroll mode as described in step 2 above.

2. Enter Zone "11".

3. Open the loops of points 1, 2 and 3.

4. Install the transmitter battery. The keypad will beep 3 times to indicate that three points have been programmed.

 Transmitter 410078:1, point 1 will be mapped to Zone 11.

 Transmitter 410078:1, point 2 will be mapped to Zone 12.

 Transmitter 410078:1, point 3 will be mapped to Zone 13.

The keypad will now display Zone 13, the last zone enrolled.

Example 2. A 2-point transmitter has the RF ID number 287613:1. Map point 1 to Zone 6 and point 2 to Zone 9.

1. Enter the Enroll mode as described above.

2. Enter Zone "06".

3. Open point-1 loop.

4. Install the battery. The keypad will beep once to indicate that one point has been programmed. (Transmitter 287613:1, point 1 will be mapped to Zone 6.)

5. Enter Zone "09".

6. Close point-1 loop and open point-2 loop.

7. Remove the transmitter battery, then re-install it. The keypad will beep once to indicate that one point has been programmed. (Transmitter 287613:1, point 2 is mapped to Zone 9.)

KEY FOB ZONE ASSIGNMENT: Key fobs can also be assigned to zones to allow multiple wireless panic buttons on one alarm system, each reporting to a central station, a pager or having a description on the keypad that describes the person holding the key fob, the location where the person holding the key fob is stationed, or the special purpose of the key fob button being depressed. See the next page on Key fob Zone Assignment.



```

KF R XMIT# + CS OP
01-0 000000:0 00
    
```

KF Area Xmitter Check Aux
ID Sum 1&2

DATA ENTRY	AUX 1/AUX 2 OPTIONS	DATA ENTRY	AUX 1/AUX 2 OPTIONS
(blank)	None	7	Relay Group 7
1	Relay Group 1	8	Relay Group 8
2	Relay Group 2	9	Keypad Panic
3	Relay Group 3	0	Aux K.P. Panic
4	Relay Group 4	B	Instant
5	Relay Group 5	C	Toggle Aux Relay
6	Relay Group 6		

Key Fob Transmitters (Press the **[FUNCTION]** button to set cursor.)

Keyfobs can be programmed as “Arm/Disarm” devices using their buttons (refer to WI752). For each Key Fob Transmitter, enter:

- ☞ the Key Fob Transmitter number (01–08).
- ☞ area number to which transmitter is assigned (1 or 2); enter 0 to disable keyfob.
- ☞ the 6-digit RF ID # printed on the transmitter (enter all numbers and/or letters, including leading “0”s, if any).
- ☞ 1-digit checksum number printed on the transmitter (enter all numbers and/or letters, including leading “0”s, if any).
- ☞ Aux-1 Option (see key fob aux 1 & aux 2 options).
- ☞ Aux-2 Option (see key fob aux 1 & aux 2 options).

Note: If the Key Fob is converted for Two Button “Emergency Use” (by cutting an internal jumper), both top or bottom buttons must be depressed to activate an alarms. In this case, the Aux-1 and Aux-2 cannot be programmed.

Press **[ON/OFF]** to save. Press NEXT (**[INTERIOR]**) button to proceed.

Key Fob Zone Assignment (refer to display as shown on the previous page: press the **[INSTANT]** button to go backwards.)

Each of the 4 key fob buttons can be assigned to a zone. For example, On button = point 1; Off button = point 2; A1 = point 3; A2 = point 4. Up to 32 key fobs (using 1 button) or 16 key fobs (using 2 buttons) or 8 key fobs (using all 4 buttons) or any combination up to a maximum of 32 controlled zones can be assigned, providing multiple wireless panic buttons on a system, each reporting to the Central Station or a pager and/or annunciating on a keypad the key fob zone number with description/location. *To assign a key fob to a zone:* program the keyfob as you would a transmitter, entering the keyfob's ID code, check sum and point number at the appropriate zone. The “Quick Method” is not allowed. The zone may be hardwired to a sensor as well as assigned to a key fob (either one will activate the zone alarm output). **NOTE:** If assigning a key fob to a zone, the “ON/OFF” buttons on the key fob will no longer arm/disarm the system. The key fob is converted to a “panic only” device.

Enter Zone Descriptions

```

01- _____
    
```

(Direct Entry)

Press the **[1]** and **[2]** buttons to place the cursor; press the **[3]** and **[6]** buttons to select the character. For each zone, enter a description of up to two lines. Press **[ON/OFF]** to save each description. To proceed to the next description, place the cursor under the Zone Number (e.g. “01”) and change the Zone Number using the **[3]** and **[6]** buttons. Program a

new description as above.

NOTE: Zone Descriptions can only be entered through the *GEM-RP1CAe2 Keypad* or by using the *Napco Quickloader Software*. See *Easy Menu Programming Worksheet* (page 45) for available zone description characters.

```

DEALER CODE
456789
    
```

(Direct Entry)

Dealer Code

Directly enter the Dealer Code (default = 456789), including leading zeros. Use the **[1]** through **[9P]** buttons. **NOTE:** Press the **[0]** button for a zero. Press **[ON/OFF]** to save.

```

DEALER CODE
RE-ENTER
    
```

(Direct Entry)

Re-enter the Dealer Code to verify the previous code. Press **[ON/OFF]** to save. Press NEXT (**[INTERIOR]**) button to proceed.

EXIT DEALER PROGRAM MODE: This completes the custom default program. Press the **[RESET]** button to enter the Direct Address Program Mode for further programming or press the **[RESET]** button once again to end all programming and resume normal keypad operation.

CLEAR PROGRAM: Should it be necessary to create a new custom default program, (a) from the Dealer Program Mode, press the **[RESET]** button to enter the Address Program Mode; (b) access Location 1197 (Clear Program); (c) press **[ON/OFF]** and start over.

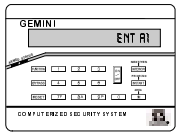
A. GEM-RP2ASe2 Keypad

Enter the Dealer Security Code (default = 456789) for a new panel or enter your custom Dealer Program Code if programmed. Press NO (**INSTANT**) repeatedly until "TURNON/PROG" is displayed. **NOTE:** If you pass "TURNON/PROG", you can scroll back by pressing the **BYPASS** button. Press YES (**INTERIOR**) to enter the Dealer Program Mode. In each of the following steps, press the **FUNCTION** button to set cursor, the NEXT (**INTERIOR**) button to go forwards, the PRIOR (**INSTANT**) button to go backwards, the **ON/OFF** button to save and the **RESET** button twice to exit at any time.

**Total Number of Zones in Area 1** *(Appears for New Panel Only)*

Directly enter the total number of zones to be programmed for Area 1. Valid entries are from 01 to 32. Directly enter the total number of zones, including leading zeros. Use number buttons **1** through **9/P**. **NOTE:** Press the **0** button for a zero. The system is based on groups of 4 zones each (after the first 8 zones), and will automatically round up to the next group of 4. For example, if you enter 18, it will automatically convert this to 20 zones. Press **ON/OFF** to save. Press NEXT (**INTERIOR**) button to proceed. **NOTE:** If you are



(Direct Entry)

programming a 2 Area system, enter the total number of zones required for Areas 1 & 2. The Direct Address Program Mode can then be used to remove zones from Area 1 and place them in Area 2. See Zone Options. If Programming a Wireless Only system, or using wireless only on Zones 9-32, enter the total number of zones in system. Enter the transmitter points in the RF Transmitter section of the Easy Menu Driven Programming Mode.

**Panel Zone Doubling** *(Appears for New Panel Only)*

If the total number of zones in Area 1 entered was 16 or greater, press YES (**INTERIOR**) to effectively double the capacity of the control panel's hard wired zones from 8 to 16. The 16 zones will no longer be EOL zones, but will be designated for Normally Closed devices only. The terminal for Zone 1 will now support Zones 1 and 9 with the use of the supplied EZ Zone Doubling™ resistors, E & Z supplied. (Refer to Wiring Diagram and Installation Instructions). If Panel Zone doubling is not desired, press NO (**INTERIOR**).



(Press YES or NO)

Fire Zones in Area 1 *(Appears for New Panel Only)*

Enter the number of any zones which are to be used as Fire Zones (both 2-wire, 4-wire or wireless). Valid entries are from 01 to 32. Directly enter each zone number, including leading zeros, and press **ON/OFF** to save, and then repeat for any additional zone(s). Press NEXT (**INTERIOR**) button to proceed.



(Direct Entry)

NOTE: If you are programming a 2 Area system, enter the total number of zones required for Areas 1 & 2. The Direct Address Program Mode can then be used to remove zones from Area 1 and place them in Area 2. See Zone Options.

ENT2WF

2-Wire Fire Zones in Area 1 (Appears for New Panel Only)

Enter the number of any Fire Zones (from previous question) which are to be used with 2-wire smoke detectors. The only valid entries are 07 and 08. Directly enter each zone number, including leading zeros. Press  to save,



ZN# __

(Direct Entry)

and then repeat for any additional zone(s). **NOTE:** Only zones which have been designated as Fire Zones in the prior question may be programmed as 2 Wire Fire zones. Press NEXT () button to proceed. **NOTE:** JP3 must be set to "2-WF" position for 2-wire fire zones (refer to Installation Instructions).

REPORT

Local or Central Station Reporting System (Appears for New Panel Only)

Press YES () button for all zones to report; press NO () button for no zones to report (LOCAL SYSTEM).



ALL ZN?

Y/N

(Press YES or NO)

Entry/Exit Zones in Area 1 (Appears for New Panel Only)

ENT EE

Directly enter the zone number of any zones which are to be used as Entry/Exit zones. Valid entries are from 01 to 32. Directly enter each zone number, including leading zeros. Use number buttons  through . **NOTE:**

ZN# __

(Direct Entry)

Press the  button for a zero. Press  to save and then repeat for any additional zone(s). Press NEXT () button to proceed.

NOTE: Chime will automatically be programmed for all E/E zones. If you are programming a 2 Area system, enter the total number of zones required for Areas 1 & 2. The Direct Address Program Mode can then be used to remove zone from Area 1 and place them in Area 2. See Zone Options.





Interior Follower Zones in Area 1 (Appears for New Panel Only)

ENTFOL

Directly enter the zone number of any zones which are to be used as Interior Follower Zones. Valid entries are from 01 to 32. Directly enter each zone number, including leading zeros. Use number buttons  through

ZN# __

(Direct Entry)

. **NOTE:** Press the  button for a zero. Press  to save and then repeat for any additional zone(s). Press NEXT () button to proceed.

NOTE: All Interior Follower zones will also be automatically programmed as "Exit/Entry Follower" zones. If you are programming a 2 Area system, enter the total number of zones required for Areas 1 & 2. The Direct Address Program Mode can then be used to remove zones from Area 1 and place them in Area 2. See Zone Options.

ENT A1

Number of Keypads in Area 1

Directly enter the total number of Keypads to be installed in Area 1. Valid entries are from 01 to 07. Directly enter the number of keypads, including leading zeros. Use number buttons through . **NOTE:** Press the button for a zero. Press to save. Press NEXT () button to proceed. **NOTE:** Area 2 keypads can only be assigned in Direct Address Programming. See Keypad Options.

#KP ____

(Direct Entry)

PHONE

Central Station Receiver 1 Telephone Number

Using number buttons, enter telephone number of up to 16 digits including-prefix letters, if necessary, for receiver 1. Use number buttons through for digits 1–9; press the button for a zero and through for letters B–F, respectively. **NOTE:** Pre-Dial Delay = “D”; Dial-Tone Detection = “E”. Pressing the button will produce a blank space (•). Press to save . Press NEXT () button to proceed.

(Direct Entry)

NOTE: Central Station Receiver 2 and 3 Telephone Numbers can only be entered in Direct Address Programming. See CS Receiver Options.

Central Station Receiver 1 Account Number

ACC #

Enter an account number of up to four digits. Use number buttons through for digits 1–9. **NOTE:** Press the button for a zero and press button for a blank space (•). Press to save . Press NEXT () button to proceed.

(____)

(Direct Entry)

NOTE: Central Station Receiver 2 and 3 Account Numbers can only be entered in Direct Address Programming. See CS Reporting Options.

Central Station Receiver 1 Format

RECFMT

From the table below, enter the central station's receiver format. Use number buttons through . **NOTE:** Press the button for a zero. and press for a blank space (•). Press through for letters B–E, respectively. Press to save. Press NEXT () button to proceed.

(0)

(Direct Entry)

NOTE: Central Station Receiver 2 and 3 Formats can only be entered in Direct Address Programming. See CS Receiver Options.

DATA ENTRY	CS RECEIVER 1 FORMAT
•(blank)	Ademco Slow, Silent Knight Slow
2	Radionics Fast
3	Silent Knight Fast
4	Radionics, DCI, Franklin Slow

DATA ENTRY	CS RECEIVER 1 FORMAT
5	Universal High Speed
B	SIA
C	Ademco Point ID
E	Pager



USER01

123 ___

(Direct Entry)

OPT1 __

(Direct Entry)

OPT2 __

(Direct Entry)

USER OPTIONS									
USER CODE (UP TO 6 DIGITS)				AREA 1 OPTIONS	AREA 2 OPTIONS				

USER AREA OPTIONS		
DATA ENTRIES		OPTION ENABLED
L	R	
blank(*)	blank(*)	Disabled
blank(*)	1	Arm/Disarm
blank(*)	2	Arm Only
blank(*)	3	Service
blank(*)	4	Access
blank(*)	Add 8	* User Program

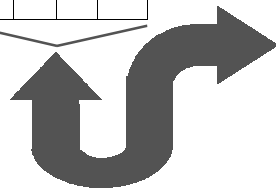

AREA OPTIONS	EXPLANATION
Disabled	User Code not active in this area.
Arm/Disarm	Allows User Code to arm/disarm this area.
Arm Only	Prevents User Code from disarming this area.
Service	A Service Code has restricted arm/disarm rights; if an area is armed with a Service Code, a "SERVICE ON" appears on the GEM-RP1CAe2 keypad (a "5" on the GEM-RP2ASe2 keypad) and the area can be disarmed with any valid User Code, including a Service Code. If the area is armed with OTHER than a Service Code, it CANNOT be disarmed with a Service Code. This is typically used to allow tradesmen access to premises under control of the owner.
Access	This is normally used to activate a door striker while an area is disarmed. Also program "Access Control on PGM2 Output" (Address 0719) and "PGM2 Output Access Control Timeout" (Address 0711).
* User Program	User Program Option is enabled for Keypad 1 only, wherever it is connected (Area 1 or Area 2). To enable User Program Option for any user add 8 to the data entry for Area 1 Option (see example). Then, User Programming can be performed only at Keypad 1 by a user code with user program enabled.

Enter User Codes (Press the **[FUNCTION]** button to set cursor.)

For default program, enter up to 32 User Codes, with Area 1 and Area 2 Options.

Press the **[FUNCTION]** button once to set the cursor to the User Code. Use the number buttons **[1]** through **[9P]** to enter a code of up to 6 digits. Enter up to 6 digits (4 digits is recommended) in the first six boxes from left to right for each user code. Valid entries are: 0-9.

NOTE: Press the **[0]** button for a zero. No blank spaces in between; leave blank (*) any trailing boxes. If "Enable Global Ambush Code" (Address 0720) is enabled and "Global Ambush Code" (Address 1054) is left blank (*), do not program the first two digits of ANY User Code as '99'.

If the programmed code was less than 6 digits, press the **[FUNCTION]** button once to set the cursor to the Area 1 Options Level. Refer to the table below for the available area options.

AREA OPTIONS: Up to 32 User Codes may be programmed.

Select the desired Area Options (Area 1 and Area 2) from the table shown and enter in the remaining four boxes for each user code.

Example: Program a code of "2222" for user 02, with area 1 options of "Arm/Disarm" and "User Program". Enter "2222" for a user code, "(blank) 9" for area 1 options and "(blank) (blank)" for area 2 options.

For Area 2 Options, press the **[FUNCTION]** button once again. Refer to the table above for available options. **NOTE:** Press the **[*]** **[0]** for blank space (*).

Press **[ON/OFF]** to save. To proceed to the next User Code, press the **[FUNCTION]** button to set the cursor to the User Number and change it using the number buttons.

Related User Options: "Enable Global Ambush Code" (Address 0720), "Global Ambush Code" (Address 1054) & "Enable Managers Mode" (Address 0719).

Program a new User Code as previously described. Remember to record your user codes in the *Easy Menu Programming Worksheet* at the back of this manual.

CHANGING OR CANCELING A CODE: To change any code, merely program over the existing code as described above and press **[ON/OFF]** to save. Similarly, to cancel a code, blank out each number of the code press **[ON/OFF]** to save to save.

ZN# 01

000000

(Direct Entry)

:0 PT.

(Direct Entry)

RF Transmitter Points (Press the Press the (FUNCTION) button to set cursor.)

(For wireless systems only. Also see Quick Method, which follows)

For each transmitter (key fob transmitters also), enter the zone number (01–32) to which the transmitter will be mapped, the 6-digit RF ID #:1-digit checksum number printed on the transmitter and box, the number of points (1–4); enter “9” for unsupervised (all points). **NOTE:** When programming the ID Code number, “A” = [*] [0]; “B” = [*] [1]; “C” = [*] [2]; “D” = [*] [3]; “E” = [*] [4]; “F” = [*] [5]. Press  to save. Press NEXT (INTERIOR) button to proceed.

Quick Method. If a receiver is already installed in the panel, Napco transmitter wireless points can be programmed automatically (“enrolled”) using the following procedure. **NOTE:** The transmitter point will be enrolled only if the signal strength is 3 or greater.

1. Enter the zone number to which the transmitter point will be mapped.

2. Press the (BYPASS) button to enter the Enroll Mode. The red and green LEDs on the keypad will flash and the window will display as shown at left.

3. Open the loop of the point that is to be programmed (GEM-TRANS2 or GEM-TRANS4 only).

4. Install the transmitter battery. The keypad will beep to indicate that the point has been successfully enrolled. Multi-point transmitters can be mapped to successive zones simultaneously (Example 1) or to selected zones point by point (Example 2).

Example 1. A 4-point transmitter has the RF ID number 410078:1. Map the first three points to Zones 11–13, respectively.

1. Enter the Enroll mode as described in step 2 above.

2. Enter Zone “11”.

3. Open the loops of points 1, 2 and 3.

4. Install the transmitter battery. The keypad will beep 3 times to indicate that three points have been programmed.

 Transmitter 410078:1, point 1 will be mapped to Zone 11.

 Transmitter 410078:1, point 2 will be mapped to Zone 12.

 Transmitter 410078:1, point 3 will be mapped to Zone 13.

The keypad will now display Zone 13, the last zone enrolled.

Example 2. A 2-point transmitter has the RF ID number 287613:1. Map point 1 to Zone 6 and point 2 to Zone 9.

1. Enter the Enroll mode as described above.

2. Enter Zone “06”.

3. Open point-1 loop.

4. Install the battery. The keypad will beep once to indicate that one point has been programmed. (Transmitter 287613:1, point 1 will be mapped to Zone 6.)

5. Enter Zone “09”.

6. Close point-1 loop and open point-2 loop.

7. Remove the transmitter battery, then re-install it. The keypad will beep once to indicate that one point has been programmed. (Transmitter 287613:1, point 2 is mapped to Zone 9.)

KEY FOB ZONE ASSIGNMENT: Key fobs can also be assigned to zones to allow multiple wireless panic buttons on one alarm system, each reporting to a central station, a pager or having a description on the keypad that describes the person holding the key fob, the location where the person holding the key fob is stationed, or the special purpose of the key fob button being depressed. *See the next page on Key fob Zone Assignment.*



KF0801

Key Fob Transmitters (Press the **[FUNCTION]** button to set cursor.)

Keyfobs can be programmed as “Arm/Disarm” devices using their buttons (refer to WI752). For each Key Fob Transmitter, enter:

AREA _

(Direct Entry)

☞ the Key Fob Transmitter number (01–08).

☞ area number to which transmitter is assigned (1 or 2); enter 0 to disable keyfob.

000000

(Direct Entry)

☞ the 6-digit RF ID # printed on the transmitter (enter all numbers and/or letters, including leading “0”s, if any).

☞ 1-digit checksum number printed on the transmitter (enter all numbers and/or letters, including leading “0”s, if any).

:0 0 0

(Direct Entry)

☞ Aux-1 Option (see key fob aux 1 & aux 2 options).

☞ Aux-2 Option (see key fob aux 1 & aux 2 options).

Note: If the Key Fob is converted for Two Button “Emergency Use” (by cutting an internal jumper), both top or

DATA ENTRY	AUX 1/AUX 2 OPTIONS	DATA ENTRY	AUX 1/AUX 2 OPTIONS
•(blank)	None	7	Relay Group 7
1	Relay Group 1	8	Relay Group 8
2	Relay Group 2	9	Keypad Panic
3	Relay Group 3	0	Aux K.P. Panic
4	Relay Group 4	B	Instant
5	Relay Group 5	C	Toggle Aux Relay
6	Relay Group 6		

bottom buttons must be depressed to activate an alarms. In this case, the Aux-1 and Aux-2 cannot be programmed.

Press  to save. Press NEXT (**[INTERIOR]**) button to proceed.

Key Fob Zone Assignment (refer to display as shown on the previous page: press the **[INSTANT]** button to go backwards.)

Each of the 4 key fob buttons can be assigned to a zone. For example, On button = point 1; Off button = point 2; A1 = point 3; A2 = point 4. Up to 32 key fobs (using 1 button) or 16 key fobs (using 2 buttons) or 8 key fobs (using all 4 buttons) or any combination up to a maximum of 32 controlled zones can be assigned, providing multiple wireless panic buttons on a system, each reporting to the Central Station or a pager and/or annunciating on a keypad the key fob zone number with description/location. *To assign a key fob to a zone:* program the keyfob as you would a transmitter, entering the keyfob's ID code, check sum and point number at the appropriate zone. The “Quick Method” is not allowed. The zone may be hardwired to a sensor as well as assigned to a key fob (either one will activate the zone alarm output). **NOTE:** If assigning a key fob to a zone, the “ON/OFF” buttons on the key fob will no longer arm/disarm the system. The key fob is converted to a “panic only” device.

ZONE DESCRIPTIONS: GEM-RP2ASe2 cannot be used to enter Zone Descriptions. To enter Zone Descriptions you must use the *GEM-RP1CAe2 Keypad or the Napco Quickloader Software.*

DCODE

(Direct Entry)

Dealer Code

Directly enter the Dealer Code (default = 456789), including leading zeros. Use the **[1]** through **[9P]** buttons. NOTE: Pres the **[0]** button for a zero. Press  to save.

RE-ENT

(Direct Entry)

Re-enter the Dealer Code to verify the previous code. Press  to save. Press NEXT (**[INTERIOR]**) button to proceed.

EXIT DEALER PROGRAM MODE: This completes the custom default program. Press the **[RESET]** button to enter the Direct Address Program Mode for further programming or press the **[RESET]** button once again to end all programming and resume normal keypad operation.

CLEAR PROGRAM: Should it be necessary to create a new custom default program, (a) from the Dealer Program Mode, press the **[RESET]** button to enter the Address Program Mode; (b) access Location 1197 (Clear Program); (c) press  and start over.

DIRECT ADDRESS PROGRAM MODE

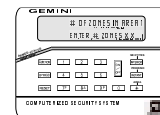

This is an extension of the Dealer Program Mode. This method of programming is used in conjunction with the Keypad Programming Worksheets that follow. Refer to these worksheets to identify the 4-digit location (address) of the feature to be programmed. An illustrative example is provided on the next page.

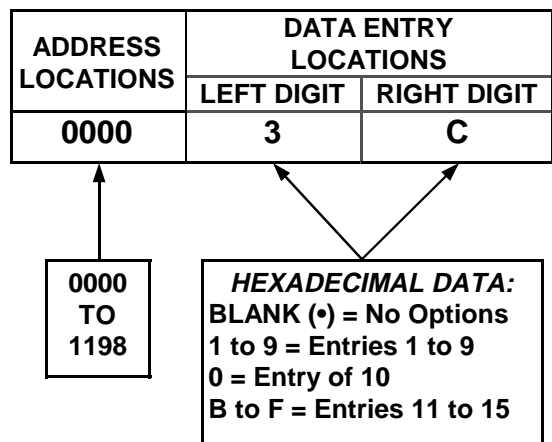

KEYPAD PROGRAMMING OVERVIEW

Direct Address Programming allows you to go directly to the address locations and change the data entries to customize your control panel options. Whereas the Easy Menu Program Mode is a simple quick start guide with limited options, the Direct Address Program Mode is more flexible allowing you to change all the options. It consists of multiple address locations (up to 1198) with two data entry locations each (left and right) as shown in the adjacent diagram.

ACCESSING DIRECT ADDRESS PROGRAM MODE

1. Press 4 5 6 7F 8A 9P FUNCTION
 Dealer Code (Default = 456789)
2. Press INSTANT Until "ACTIVATE PROGRAM Y/N" (GEM-RP1CAe2) or "TURN ON PROG Y/N" (GEM-RP2ASe2) appears on LCD screen.
3. Press INTERIOR To Enter Dealer Program Mode
4. Press RESET To Exit Easy Menu Driven Program Mode & Enter Direct Address Program Mode

WHAT YOU SEE ON THE KEYPAD

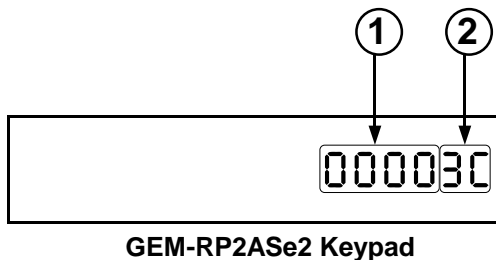
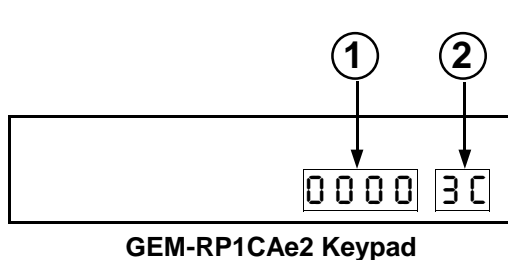

- ① = ADDRESS LOCATION
- ② = DATA ENTRY LOCATION

DIRECT ADDRESS PROGRAM MODE

DIRECT ADDRESS PROGRAM MODE KEYPAD COMMANDS

A. GEM-RP1CAe2 Keypads

TO ACCESS, PRESS **[RESET]**
IN DEALER PROGRAM MODE.

1. TOGGLE CURSOR TO
4-DIGIT ADDRESS FIELD
USING **[FUNCTION]** BUTTON.

2. ENTER ADDRESS NUMBER
DIRECTLY USING NUMBER
BUTTONS.

3. ENTER DATA DIRECTLY
USING NUMBER BUTTONS.*

4. PRESS **[ON/OFF]** TO SAVE.

TO EXIT, PRESS **[RESET]**.

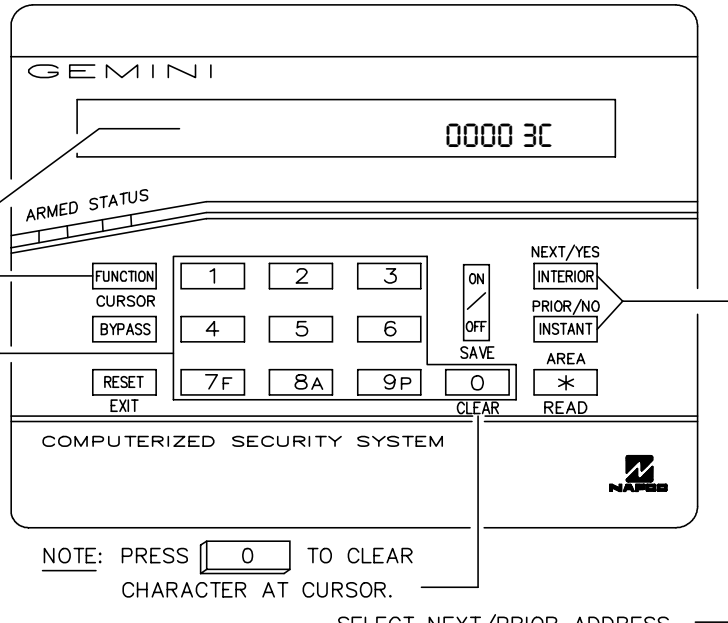

NOTE: PRESS **[0]** TO CLEAR
CHARACTER AT CURSOR.

SELECT NEXT/PRIOR ADDRESS.

(PRESS **[*]** **[NEXT]** TO JUMP TO NEXT PROGRAMMING BLOCK.

PRESS "[][0]"-"[*][5]" FOR 10-15 (A-F), RESPECTIVELY.

DIRECT ADDRESS PROGRAM MODE

B. GEM-RP2ASe2 Keypad

TO ACCESS, PRESS **[RESET]**
IN DEALER PROGRAM MODE.

1. TOGGLE CURSOR TO 4-DIGIT
ADDRESS FIELD USING
[FUNCTION] BUTTON.

2. ENTER ADDRESS
NUMBER DIRECTLY
USING NUMBER BUTTONS.

3. ENTER DATA DIRECTLY
USING NUMBER BUTTONS.*

4. PRESS **[ON/OFF]** TO SAVE.

TO EXIT, PRESS **[RESET]**.

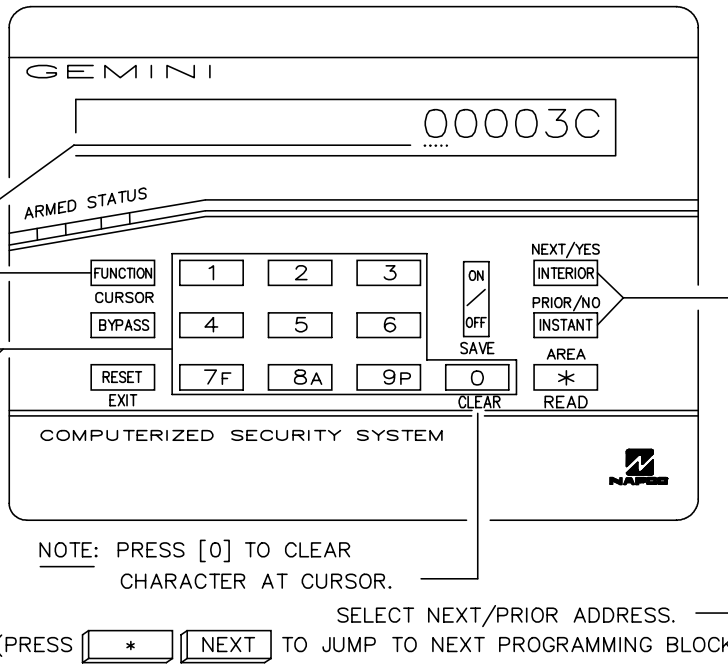

NOTE: PRESS **[0]** TO CLEAR
CHARACTER AT CURSOR.

SELECT NEXT/PRIOR ADDRESS.

(PRESS **[*]** **[NEXT]** TO JUMP TO NEXT PROGRAMMING BLOCK.



PRESS "[][0]"-"[*][5]" FOR 10-15 (A-F), RESPECTIVELY.

The displays shown on the previous page will appear after a brief delay.

 Use the the **[BYPASS]** button to toggle the cursor between the 4-digit address field and the data entry locations.

 Enter the address directly using the number buttons.

 The contents of the address will be read automatically, along with the feature name and programming information. The cursor will advance to the data field. Enter the required data directly using the number buttons.

 Press  to save the contents of each address.

EXIT DIRECT ADDRESS PROGRAM MODE: When done, press the **[RESET]** button to exit and resume normal keypad operation. The panel is now programmed with your default program.

PROGRAMMING OVERVIEW



The Keypad Programming Worksheets in the back are provided as an address-programming reference to help the installer modify his custom default program or to make minor field alterations to an existing panel program. It is recommended that the panel be uploaded to Napco's Quickloader software following any keypad programming and that the PCD3000's error-check feature be utilized to reduce the possibility of programming omissions or conflicts.







Note: Most of the addresses shown comprise two data entry locations, left and right digits. Program the left digits on the left data-display segment, and the right digit on the right segment. For those addresses having only one programmable nibble, program the right segment only; the left segment should display a blank (•).

Keep the Keypad Programming Worksheets on file for future reference.

General Programming Steps

 1. Contact the central station to ascertain receiver format, data format, event codes, subscriber numbers and telephone number(s).

 2. Select the desired features by circling  the respective "address" boxes. Refer to the Programming Options and Worksheets for guidance in selecting the "data" (1,2,4,8) to be entered into those boxes.

 3. Program the data entered in the boxes on the worksheets into the respective addresses. The display will show the entry numerically, but will display "0" for the number 10, and letters "B", "C", "D", "E", and "F" for the numbers 11 through 15, respectively. To program a 10, press  . To program 11 through 15, press   through  , respectively.

NOTE: See the Direct Address Programming Example on the following page.

























DATA ENTRY SELECTIONS (BINARY VALUE CIRCLED) 				ENTRY TOTAL	PRESS 	KEYPAD DISPLAYS
8	4	2	1	blank		•
8	4	2	①	1		1
8	4	②	1	2		2
8	4	②	①	3		3
8	④	2	1	4		4
8	④	2	①	5		5
8	④	②	1	6		6
8	④	②	①	7		7
⑧	4	2	1	8		8
⑧	4	2	①	9		9
⑧	4	②	1	10	 	0
⑧	4	②	①	11	 	B
⑧	④	2	1	12	 	C
⑧	④	2	①	13	 	D
⑧	④	②	1	14	 	E
⑧	④	②	①	15	 	F

Table 1. Determining data entry for a location (each "nibble"). Numbers in parentheses indicate data for selected zones or features. (See Programming Worksheets that follow.)

DIRECT ADDRESS PROGRAM MODE

Direct Address Programming Example

Example: Program Zones 6, 7 and 8 as Exit/Entry Follower Zones.

DETERMINE THE DATA ENTRIES

1. Referring to ZONE FEATURES in the Programming Worksheets that follow, Exit/Entry Follower for Zones 5 through 8 are located at address 0506, left digit. Circle the data values for Zones 5–8.
2. Add the data values for Zones 6, 7 and 8: $2+4+8=14$. From Tables 1 and 2, "14" (E) is entered as press . The right digit (for Zones 1 through 4, none of which are Exit/Entry Follower Zones) is entered as a blank (•).

ZONE OPTION	ZONES LEFT DATA VALUES				ADDRESS			ZONES RIGHT DATA VALUES			
	SUM = 14 (CIRCLE)				0506			SUM = 0 (CIRCLE)			
	ZN08	ZN07	ZN06	ZN05	L	ADDR	R	ZN04	ZN03	ZN02	ZN01
EXIT/ENTRY FOLLOWER	8	4	2	1	E	0506	blank (•)	8	4	2	1

ENTER DATA

PROGRAM THE DATA ENTRIES

1. Enter the panel's Dealer Code (Default = 456789), then press the button.
2. Answer NO () to all questions until "ACTIVATE PROGRAM Y/N" is displayed; then press YES ().
NOTE: If you pass "ACTIVATE PROGRAM", scroll backward using the button.
3. Press the button to enter the Address Program Mode. Address "0000" will display.
4. Press to access Address 0506. The data for both digits will display and the cursor will advance to the data field.
5. Press to enter an "E" in the left digit and press to enter a blank (•) in the right digit.
6. Press to save.

Address 0506 is now programmed with "E•".

DIRECT ADDRESS PROGRAM MODE

PROGRAMMING OPTIONS & WORKSHEETS

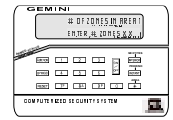

PROGRAMMING OPTIONS & WORKSHEETS

1. Press **4** **5** **6** **7F** **8A** **9P** **FUNCTION**
↙ Dealer Code ↘
2. Press **INSTANT** Until "ACTIVATE PROGRAM Y/M" (GEM-RP1CAe2) or "TURN ON PROG Y/M" (GEM-RP2ASe2) appears on LCD screen.
3. Press **INTERIOR** To Enter Dealer Program Mode
4. Press **RESET** To Exit Easy Menu Driven Program Mode & Enter Direct Address Program Mode

GEM-RP1CAe2 Keypad

TO ACCESS, PRESS **RESET** IN DEALER PROGRAM MODE.

1. TOGGLE CURSOR TO 4-DIGIT ADDRESS FIELD USING **FUNCTION** BUTTON.
2. ENTER ADDRESS NUMBER DIRECTLY USING NUMBER BUTTONS.
3. ENTER DATA DIRECTLY USING NUMBER BUTTONS.*
4. PRESS **ON/OFF** TO SAVE.

TO EXIT, PRESS **RESET**.

NOTE: PRESS **0** TO CLEAR CHARACTER AT CURSOR.

SELECT NEXT/PRIOR ADDRESS. (PRESS ***** **NEXT** TO JUMP TO NEXT PROGRAMMING BLOCK.

PRESS "[][0]"-"[*][5]" FOR 10-15 (A-F), RESPECTIVELY.

ENTRY TOTAL	PRESS	KEYPAD DISPLAYS
blank	0	•
1	1	1
2	2	2
3	3	3
4	4	4
5	5	5
6	6	6
7	7F	7
8	8A	8
9	9P	9
10	* 0	0
11	* 1	B
12	* 2	C
13	* 3	D
14	* 4	E
15	* 5	F

Determining data entry for a location (each "nibble"). Numbers in parentheses indicate data for selected zones or features. (See Programming Worksheets that follow.)

GEM-RP2ASe2 Keypad

TO ACCESS, PRESS **RESET** IN DEALER PROGRAM MODE.

1. TOGGLE CURSOR TO 4-DIGIT ADDRESS FIELD USING **FUNCTION** BUTTON.
2. ENTER ADDRESS NUMBER DIRECTLY USING NUMBER BUTTONS.
3. ENTER DATA DIRECTLY USING NUMBER BUTTONS.*
4. PRESS **ON/OFF** TO SAVE.

TO EXIT, PRESS **RESET**.

NOTE: PRESS **0** TO CLEAR CHARACTER AT CURSOR.

SELECT NEXT/PRIOR ADDRESS. (PRESS ***** **NEXT** TO JUMP TO NEXT PROGRAMMING BLOCK.

PRESS "[][0]"-"[*][5]" FOR 10-15 (A-F), RESPECTIVELY.

SYSTEM DELAYS & TIMEOUTS (ADDRESS 0000 TO 0002, 0711 & 0715)

EXIT DELAY (sec.)	ADDRESS 0000	
	LEFT	RIGHT

[Default = 3C]

ENTRY DELAY 1 (sec.)	ADDRESS 0001	
	LEFT	RIGHT

[Default = 1E]

ENTRY DELAY 2 (sec.)	ADDRESS 0002	
	LEFT	RIGHT

[Default = 1E]

PGM2 Output Access Control Timeout (sec.)	ADDRESS 0711	
	LEFT	RIGHT

ABORT DELAY (sec.)	ADDRESS 0715	
	LEFT	RIGHT

[Default = blank (•) blank (•)]

DATA ENTRIES		DELAY/ TIMEOUT
LEFT	RIGHT	
blank (•)	blank (•)	0 sec.
blank (•)	F	15 sec.
1	E	30 sec.
2	D	45 sec.
3	C	60 sec.
5	0	90 sec.
7	8	120 sec.
↓	↓	↓
↓	↓	↓
F	F	255 sec.

1. Select delay/timeout (0-255 sec.) from the table shown.
2. Enter in corresponding address locations above (left and right digits).
3. For a desired delay/timeout not listed do the following:
 - A. Choose a desired delay/timeout, ex: 20 sec.
 - B. Divide it by 16

$$\begin{array}{r}
 \textcircled{1} \text{ Quotient} \longrightarrow \text{Left Digit} \\
 16 \overline{) 20} \\
 \underline{-16} \\
 \textcircled{4} \text{ Remainder} \longrightarrow \text{Right Digit}
 \end{array}$$

EXIT/ENTRY DELAYS: Apply only to zones programmed with the following options "Entry/Exit 1, Entry/Exit 2, Exit/Entry Follower". For UL Installations, the maximum exit delay is 60 seconds and the maximum entry delay is 45 seconds.

PROGRAMMING TIMEOUTS: Either use the tables provide or calculate your own timeout using the steps indicated. **WARNING:** Timers have uncertainty of +0/-1sec, so a "time" of 1 second may actually timeout IMMEDIATELY.

SYSTEM DELAYS & TIMEOUTS (ADDRESS 0716 & 0717)

CHIME TIMEOUT (¼sec.)	ADDRESS 0716	
	LEFT	RIGHT

[Default = blank (•) 2]

AC Fail Report Delay (min.)	ADDRESS 0717	
	LEFT	RIGHT

[Default = blank (•) blank (•)]

DEFAULTS: The defaults shown on this page and on the following pages are automatically set after exiting the Easy Menu Driven Mode.

CHIME TIMEOUT OPTIONS		
DATA ENTRIES		TIMEOUT
LEFT	RIGHT	
blank (•)	blank (•)	0 ¼sec. = 0 sec.
blank (•)	2	2 ¼sec. = ½ sec.
blank (•)	3	3 ¼sec. = ¾ sec.
blank (•)	4	4 ¼sec. = 1 sec.
blank (•)	5	5 ¼sec. = 1.25 sec.
blank (•)	6	6 ¼sec. = 1.5 sec.
blank (•)	7	7 ¼sec. = 1.75 sec.
blank (•)	8	8 ¼sec. = 2 sec.
↓	↓	↓
↓	↓	↓
F	F	255 ¼sec. = 63.25 sec.

AC FAIL REPORT DELAY OPTIONS		
DATA ENTRIES		DELAY
LEFT	RIGHT	
blank (•)	blank (•)	0 min.
blank (•)	1	1 min.
blank (•)	2	2 min.
blank (•)	3	3 min.
blank (•)	4	4 min.
blank (•)	5	5 min.
blank (•)	6	6 min.
blank (•)	7	7 min.
↓	↓	↓
↓	↓	↓
F	F	255 min. = 4 Hr., 30 min.

1. Select delay/timeout from the table shown.
2. Enter in corresponding address locations above (left and right digits).
3. For a desired delay/timeout not listed do the following:
 - A. Choose a desired delay/timeout, ex: 20
 - B. Divide it by 16

$$\begin{array}{r}
 \textcircled{1} \text{ Quotient} \longrightarrow \text{Left Digit} \\
 16 \overline{) 20} \\
 \underline{-16} \\
 \textcircled{4} \text{ Remainder} \longrightarrow \text{Right Digit}
 \end{array}$$

PROGRAMMING STEPS:

1. Lookup desired Programming Option by Address Location (highlighted in black).
2. Select the programming option data entry from the tables shown.
3. Enter the selected data entry in the boxes shown.
4. For more information on a programming option refer to the Glossary at the end of this manual.

SYSTEM OUTPUT TIMEOUTS (ADDRESS 0710, 0712, 0713 & 0714)

PGM2 Output Timeout (min.)	ADDRESS 0710	
	LEFT	RIGHT
	blank (•)	blank (•)

[Default = blank (•) blank (•)]

Alarm Output Timeout (min.)	ADDRESS 0712	
	LEFT	RIGHT
	1 blank (•)	blank (•)

[Default = 1 blank (•)]

Pulse Alarm Output Timeout (min.)	ADDRESS 0713	
	LEFT	RIGHT
	1 blank (•)	blank (•)

[Default = 1 blank (•)]

PGM1 Output Timeout (min.)	ADDRESS 0714	
	LEFT	RIGHT
	blank (•)	blank (•)

[Default = blank (•) blank (•)]

DATA ENTRIES		DELAY/ TIMEOUT
LEFT	RIGHT	TIMEOUT
blank (•)	blank (•)	0 min.
blank (•)	1	1 min.
blank (•)	2	2 min.
blank (•)	3	3 min.
blank (•)	4	4 min.
blank (•)	5	5 min.
blank (•)	6	6 min.
1	blank (•)	16 min.
↓	↓	↓
F	F	255 min.

1. Select delay/timeout (0-255 min.) from the table shown.
2. Enter in corresponding address locations above (left and right digits).
3. For a desired delay/timeout not listed do the following:
 - Choose a desired delay/timeout, ex: 20 min.
 - Divide it by 16

$$\begin{array}{r}
 \textcircled{1} \text{ Quotient} \longrightarrow \text{Left Digit} \\
 16 \overline{)20} \\
 \underline{-16} \\
 \textcircled{4} \text{ Remainder} \longrightarrow \text{Right Digit}
 \end{array}$$

OUTPUT TIMEOUTS: If a timeout of "0 min." is selected, then the output will remain active (ON) until the system is reset or disarmed. For UL Residential Installations, the minimum timeout is 4 minutes. For UL Commercial Installations, the minimum

DOWNLOAD/CALLBACK OPTIONS (ADDRESS 1183 & 0236-0255)

No. Rings Before Pickup	ADDRESS 1183	
	LEFT	RIGHT
	blank (•)	blank (•)

[Default = blank (•) blank (•)]

NUMBER OF RINGS BEFORE PICKUP: Enter the number of rings before automatic pickup by the control panel when downloading from a computer (see Glossary at the back for more information).



1. Enter in right digit only (left digit is not used).
2. Valid entries are: 1-9, 0 = 10, B = 11, C = 12, D = 13, E = 14, F = 15

NOTE: Default is 15 Rings. Dark shaded data shows option not available.

Callback Telephone Number (Digits 1-20)	ADDRESS 0236-0255 (RIGHT DIGITS 1-20)																			
	0236	0237	0238	0239	0240	0241	0242	0243	0244	0245	0246	0247	0248	0249	0250	0251	0252	0253	0254	0255
	R	R	R	R	R	R	R	R	R	R	R	R	R	R	R	R	R	R	R	R

[Default = blank (•) for all digits 1-20]

CALLBACK TELEPHONE NUMBER: Enter telephone number to be used when downloading from a computer (see Glossary at the back for more information).

1. Enter in right digit only (left digit is not used).
2. Enter up to 20 digits from left to right. **NOTE:** Leave trailing boxes blank (•).
3. Valid entries are: 1-9, B = , C = , D = 3 sec. pause, E = Wait for dial tone, F = ignore location

PAGER FORMAT OPTIONS (ADDRESS 0256 & 0257)

Leading Digits for Pager Format (1st Digit)	ADDRESS 0256	
	LEFT	RIGHT
	blank (•)	blank (•)

LEADING DIGITS FOR PAGER FORMAT: In Pager Format reporting, the message typically begins with "00".. However, for some pager services, this will cause the Pager's Voice Mail feature to activate. This option allows you to program these digits to any number desired. Typical Pager report is "003 022 1234", where 3 is the Event, 22 is the zone, and 1234 is the Subscriber ID number. For example, if the Leading Digits are programmed as "98", the Pager report will now appear as "983 022 1234". **NOTE:** See CS Receiver Options to select Pager Format.

Leading Digits for Pager Format (2nd Digit)	ADDRESS 0257	
	LEFT	RIGHT
	blank (•)	blank (•)

1. Enter in 1st and 2nd Leading Digits in right digit only (left digit is not used) as shown.
2. Valid entries are: 0-9.

[Default = blank (•) blank (•) for both]



SYSTEM OPTIONS (ADDRESS 0460-0485 & 1054)

PROGRAMMING OPTIONS & WORKSHEETS

SYSTEM RESPONSE AC- TIVATED BY GLOBAL EVENT/TROUBLE	GLOBAL SYSTEM EVENT/TROUBLE				ADDRESS			GLOBAL SYSTEM EVENT/TROUBLE			
	LEFT DATA VALUES (CIRCLE)				0460-0469			RIGHT DATA VALUES (CIRCLE)			
	Bell Superv.	EZM TAMPER	AC FAIL	LOW BATTERY	LEFT	ADDR	RIGHT	MEMORY FAILURE	RF RCVR. TROUBLE	TELCO FAILURE	TEST TIMER
Alarm Output	8	4	2	1		0460		8	4	2	1
Pulsed Alarm Output	8	4	2	1		0461		8	4	2	1
PGM1 Output	8	4	2	1		0462		8	4	2	1
PGM2 Output	8	4	2	1		0463		8	4	2	1
Report Event Telco 1	8	4	2	1		0464		8	4	2	1
Report Restore Telco 1	8	4	2	1		0465		8	4	2	1
Report Event Telco 3	8	4	2	1		0468		8	4	2	1
Report Restore Telco 3	8	4	2	1		0469		8	4	2	1

See NOTE [Default = blank (•) blank (•) from address 0460-0469]

SYSTEM RESPONSE AC- TIVATED BY AREA 1 EVENT/TROUBLE	AREA 1 SYSTEM EVENT/TROUBLE				ADDRESS			AREA 1 SYSTEM EVENT/TROUBLE			
	LEFT DATA VALUES (CIRCLE)				0470-0477			RIGHT DATA VALUES (CIRCLE)			
	Keyfob Low Batt.	FAIL TO CLOSE	FAIL TO OPEN	KEYPAD TAMPER	LEFT	ADDR	RIGHT	KEYPAD AUXILIARY	KEYPAD FIRE	KEYPAD PANIC	AMBUSH
Pulsed Alarm Output	8	4	2	1		0470		8	4	2	1
Alarm Output	8	4	2	1		0471		8	4	2	1
PGM1 Output	8	4	2	1		0472		8	4	2	1
PGM2 Output	8	4	2	1		0474		8	4	2	1
Report Event Telco 1	8	4	2	1		0475		8	4	2	1
Report Event Telco 3	8	4	2	1		0477		8	4	2	1

[Default = blank (•) blank (•) from address 0470-0477]

SYSTEM RESPONSE AC- TIVATED BY AREA 2 EVENT/TROUBLE	AREA 2 SYSTEM EVENT/TROUBLE				ADDRESS			AREA 2 SYSTEM EVENT/TROUBLE			
	LEFT DATA VALUES (CIRCLE)				0478-0485			RIGHT DATA VALUES (CIRCLE)			
	Keyfob Low Batt.	FAIL TO CLOSE	FAIL TO OPEN	KEYPAD TAMPER	LEFT	ADDR	RIGHT	KEYPAD AUXILIARY	KEYPAD FIRE	KEYPAD PANIC	AMBUSH
Pulsed Alarm Output	8	4	2	1		0478		8	4	2	1
Alarm Output	8	4	2	1		0479		8	4	2	1
PGM1 Output	8	4	2	1		0480		8	4	2	1
PGM2 Output	8	4	2	1		0482		8	4	2	1
Report Event Telco 1	8	4	2	1		0483		8	4	2	1
Report Event Telco 3	8	4	2	1		0485		8	4	2	1

[Default = blank (•) blank (•) from address 0478-0485]

1. Select the desired option by circling the data values for each digit (left and right).
2. Add the data values (ex: 15=1+2+4+8) from the selected options.
3. Enter in address location (left and right digits).

NOTE: Dark shaded data value box shows option not available.



Global Ambush Code	ADDRESS 1054	
	LEFT	RIGHT

[Default = blank (•) blank (•)]



GLOBAL AMBUSH CODE: It is the 2-digits entered immediately prior to the regular disarm code. If "Enable Global Ambush Code" (Address 0720) is selected and Address 1054 is left blank (•), then the 2-digit Global Ambush Code is "99". If "Enable Global Ambush Code" is selected and Address 1054 is **not** left blank (•), then the 2-digit Global Ambush Code is the two digits entered in address 1054.

Enter in address location (both left and right digits) ; valid entries are 1-9.



SYSTEM OPTIONS (ADDRESS 0718, 0719, 0721 & 0722)

SYSTEM OPTIONS	LEFT DATA VALUES (CIRCLE )	ADDRESS 0718		RIGHT DATA VALUES (CIRCLE )	SYSTEM OPTIONS
RESERVED	1	LEFT DIGIT (SUM OF DATA VALUES)	RIGHT DIGIT (SUM OF DATA VALUES)	1	Opening Report Only after Alarm Report
Enable AutoArm if not closed at end of windows	2			2	Closing Report Only on Conditional Close
Disable Time/Date at Keypad	4			4	Incl. Sel./Grp. Bypass in Cond. Close /Status Report
RESERVED	8			8	



[Default = blank (•) blank (•)]

SYSTEM OPTIONS	LEFT DATA VALUES (CIRCLE )	ADDRESS 0719		RIGHT DATA VALUES (CIRCLE )	SYSTEM OPTIONS
Access Control on PGM2 Output	1	LEFT DIGIT (SUM OF DATA VALUES)	RIGHT DIGIT (SUM OF DATA VALUES)	1	Auto Bell Test on Arming
Maintained Keyswitch Arming	2			2	Auto Reset after Burglary Output Timeout
Enable Manager's Mode	4			4	Suppress Reminder when Armed
Disable Instant Mode	8			8	Enable Local Alarm on First "ZoneAND" Trip



[Default = blank (•) blank (•)]

SYSTEM OPTIONS	LEFT DATA VALUES (CIRCLE )	ADDRESS 0720		RIGHT DATA VALUES (CIRCLE )	SYSTEM OPTIONS
Disable Keypad Function Mode Download	1	LEFT DIGIT (SUM OF DATA VALUES)	RIGHT DIGIT (SUM OF DATA VALUES)	1	Interior 1 Normally Bypassed
Disable Callback Download	2			2	Enable Global Ambush Code *
PGM2 Output Chirp on Keyfob Arming	4			4	Reset Day Zone with Arm/Disarm Only
Change Pulse Output to Cadence	8			8	Enable Residential Fire





[Default = blank (•) blank (•)]

SYSTEM OPTIONS	LEFT DATA VALUES (CIRCLE )	ADDRESS 0721		RIGHT DATA VALUES (CIRCLE )	SYSTEM OPTIONS
Line-Fault Test only when Armed	1	LEFT DIGIT (SUM OF DATA VALUES)	RIGHT DIGIT (SUM OF DATA VALUES)	1	Enable Zone Doubling (Zones 9-16)
Enable Line-Fault Test	2			2	Wireless Trouble Activates Telco 1
RESERVED	4			4	Wireless Trouble Activates Telco 3
RESERVED	8			8	RESERVED

Default depends on Easy Menu Question "EZ ZONE DOUBLING? Y/N".
If yes, then [Default = (blank) 1]. If no, then [Default = (blank) (blank)].

SYSTEM OPTIONS	LEFT DATA VALUES (CIRCLE )	ADDRESS 0722		RIGHT DATA VALUES (CIRCLE )	SYSTEM OPTIONS
Don't Clear PGM2 Output with Arm/Disarm	1	LEFT DIGIT (SUM OF DATA VALUES)	RIGHT DIGIT (SUM OF DATA VALUES)	1	Automatic Interior Bypass
2nd Ring Download (Dis. Ans. Machine Override)	2			2	Veri-phone Zones Trip PGM2 Output
RESERVED	4			4	Veri-phone Zones over Priority Alarms
RESERVED	8			8	Resound on Wireless Smoke Low Battery

[Default = blank (•) blank (•)]

-  1. Select the desired option by circling  the data values for each digit (left and right).
-  2. Add the data values (ex: 15=1+2+4+8) from the selected options.
-  3. Enter in address location (left and right digits).

*** NOTE:** If "Enable Global Ambush Code" in Address 0720 is selected, then program the 2-digit "Global Ambush Code" in Address 1054. If Address 1054 is left blank (•), then, the 2-digit "Global Ambush Code" will be "99".

NOTE: To select "Line-Fault Test only when Armed", you must also select "Enable Line-Fault Test" at address 0721.



CS RECEIVER OPTIONS (ADDRESS 0171-0191, 0192-0213, 0214-0235)

PROGRAMMING OPTIONS & WORKSHEETS

CS Receiver 1 Format	ADDRESS 0170	
	LEFT	RIGHT
	blank (*)	

CS Receiver 2 Format	ADDRESS 0192	
	LEFT	RIGHT
	blank (*)	

CS Receiver 3 Format	ADDRESS 0193	
	LEFT	RIGHT
	blank (*)	

DATA ENTRY	CS RECEIVER 1 FORMAT
blank (*)	Ademco Slow, Silent Knight Slow
2	Radionics Fast
3	Silent Knight Fast
4	Radionics, DCI, Franklin Slow
5	Universal High Speed
B	SIA
C	Ademco Point ID
E	Pager *

Default for CS Receiver 1 Format depends on Easy Menu Question "RCVR FORMAT". [Default = *(blank) *(blank)] for CS Receivers 2 and 3 Formats.

CS RECEIVER FORMATS: Up to 3 CS Formats may be programmed.

- Select the desired CS Receiver Format from the table shown.
- Enter in the corresponding right digit address location (left digit is not used) for each CS Receiver. **NOTE:** Dark shaded data value box shows option not available.

NOTE: * See Pager Format Options to program Leading Digits for Pager Format.

CS RECEIVER 1 OPTIONS	LEFT DATA VALUES (CIRCLE)	ADDRESS 0171	RIGHT DATA VALUES (CIRCLE)	CS RECEIVER 1 OPTIONS
Sum Check	1	LEFT DIGIT (SUM OF DATA VALUES)		1
3/1 with Extended Restores	2	RIGHT DIGIT (SUM OF DATA VALUES)		2
RESERVED	4			4
RESERVED	8			8
[Default = blank (*) blank (*)]				
CS RECEIVER 2 OPTIONS	LEFT DATA VALUES (CIRCLE)	ADDRESS 0193	RIGHT DATA VALUES (CIRCLE)	CS RECEIVER 2 OPTIONS
Sum Check	1	LEFT DIGIT (SUM OF DATA VALUES)		1
3/1 with Extended Restores	2	RIGHT DIGIT (SUM OF DATA VALUES)		2
RESERVED	4			4
RESERVED	8			8
[Default = blank (*) blank (*)]				
CS RECEIVER 3 OPTIONS	LEFT DATA VALUES (CIRCLE)	ADDRESS 0215	RIGHT DATA VALUES (CIRCLE)	CS RECEIVER 3 OPTIONS
Sum Check	1	LEFT DIGIT (SUM OF DATA VALUES)		1
3/1 with Extended Restores	2	RIGHT DIGIT (SUM OF DATA VALUES)		2
RESERVED	4			4
RESERVED	8			8
[Default = blank (*) blank (*)]				

CS RECEIVER OPTIONS: Select options for any of the three CS Receivers.

- Select the desired option by circling the data values for each digit (left and right).
- Add the data values (ex: 15=1+2+4+8) from the selected options.
- Enter in address location (left and right digits).

NOTE: Dark shaded data value box shows option not available.

NOTE: * If both are selected, 1400Hz has priority over 2300Hz.

CS Receiver 1 Telephone Number (Digits 1-20)	ADDRESS 0172-0191 (RIGHT DIGITS 1-20)																			
	0172	0173	0174	0175	0176	0177	0178	0179	0180	0181	0182	0183	0184	0185	0186	0187	0188	0189	0190	0191
	R	R	R	R	R	R	R	R	R	R	R	R	R	R	R	R	R	R	R	R
CS Receiver 2 Telephone Number (Digits 1-20)	ADDRESS 0194-0213 (RIGHT DIGITS 1-20)																			
	0194	0195	0196	0197	0198	0199	0200	0201	0202	0203	0204	0205	0206	0207	0208	0209	0210	0211	0212	0213
	R	R	R	R	R	R	R	R	R	R	R	R	R	R	R	R	R	R	R	R
CS Receiver 3 Telephone Number (Digits 1-20)	ADDRESS 0216-0235 (RIGHT DIGITS 1-20)																			
	0216	0217	0218	0219	0220	0221	0222	0223	0224	0225	0226	0227	0228	0229	0230	0231	0232	0233	0234	0235
	R	R	R	R	R	R	R	R	R	R	R	R	R	R	R	R	R	R	R	R

Default for CS Receiver 1 Telephone Number depends on Easy Menu Question "CENTRAL PHONE #".

[Default = blank (*)] across digits 1-20 for CS Receiver Telephone Numbers 2 and 3.

CS RECEIVER TELEPHONE NUMBERS: Enter telephone numbers for any of the three CS Receivers (Telco 1, 2 & 3).

- Enter in right digit only (left digit is not used).
- Enter up to 20 digits from left to right. **NOTE:** Leave trailing boxes blank (*).
- Valid entries are: 1-9, B = , C = , D = 3 sec. pause, E = Wait for dial tone, F = ignore location

CS SUBSCRIBER ID & SYSTEM REPORTING OPTIONS (ADDRESS 0259-0347)

PROGRAMMING OPTIONS & WORKSHEETS

CS Telco 1 Subscriber Opening/Closing ID Number (Area 1)	ADDRESS 0259-0262 (RIGHT DIGITS 1-4)			
	0259	0260	0261	0262
	R	R	R	R
CS Telco 1 Subscriber Event ID Number (Area 1)	ADDRESS 0267-0270 (RIGHT DIGITS 1-4)			
	0267	0268	0269	0270
	R	R	R	R

CS Telco 1 Subscriber Opening/Closing ID Number (Area 2)	ADDRESS 0263-0266 (RIGHT DIGITS 1-4)			
	0263	0264	0265	0266
	R	R	R	R
CS Telco 1 Subscriber Event ID Number (Area 2)	ADDRESS 0271-0274 (RIGHT DIGITS 1-4)			
	0271	0272	0273	0274
	R	R	R	R

CS Telco 1 Subscriber Event ID Number(System)	ADDRESS 0275-0278 (RIGHT DIGITS 1-4)			
	0275	0276	0277	0278
	R	R	R	R

CS Telco 2 Subscriber Opening/Closing ID Number (Area 1)	ADDRESS 0279-0282 (RIGHT DIGITS 1-4)			
	0279	0280	0281	0282
	R	R	R	R
CS Telco 2 Subscriber Event ID Number (Area 1)	ADDRESS 0287-0290 (RIGHT DIGITS 1-4)			
	0287	0288	0289	0290
	R	R	R	R

CS Telco 2 Subscriber Opening/Closing ID Number (Area 2)	ADDRESS 0283-0286 (RIGHT DIGITS 1-4)			
	0283	0284	0285	0286
	R	R	R	R
CS Telco 2 Subscriber Event ID Number (Area 2)	ADDRESS 0291-0294 (RIGHT DIGITS 1-4)			
	0291	0292	0293	0294
	R	R	R	R

CS Telco 2 Subscriber Event ID Number (System)	ADDRESS 0295-0298 (RIGHT DIGITS 1-4)			
	0295	0296	0297	0298
	R	R	R	R

CS Telco 3 Subscriber Opening/Closing ID Number (Area 1)	ADDRESS 0299-0302 (RIGHT DIGITS 1-4)			
	0299	0300	0301	0302
	R	R	R	R
CS Telco 3 Subscriber Event ID Number (Area 1)	ADDRESS 0307-0310 (RIGHT DIGITS 1-4)			
	0307	0308	0309	0310
	R	R	R	R

CS Telco 3 Subscriber Opening/Closing ID Number (Area 2)	ADDRESS 0303-0306 (RIGHT DIGITS 1-4)			
	0303	0304	0305	0306
	R	R	R	R
CS Telco 3 Subscriber Event ID Number (Area 2)	ADDRESS 0311-0314 (RIGHT DIGITS 1-4)			
	0311	0312	0313	0314
	R	R	R	R

CS Telco 3 Subscriber Event ID Number (System)	ADDRESS 0315-0318 (RIGHT DIGITS 1-4)			
	0315	0316	0317	0318
	R	R	R	R

Default for CS Telco 1 Subscriber Event ID Number (Area 1) depends on Easy Menu Question "ACCOUNT #". [Default = blank (•) blank (•) blank (•) blank (•)] for all other ID Numbers.

CS TELCO SUBSCRIBER ID NUMBERS: Enter the Subscriber Opening/Closing and Event ID Numbers for any of the 3 CS Receivers.

1. Enter in corresponding right digit address location (left digit is not used).
2. Enter 3 or 4 digits (depending on the CS receiver format) for each subscriber number from left to right. **NOTE:** Leave trailing boxes blank (•).
3. Valid entries are: 1-9, 0 and B-F. **NOTE:** A is not permitted.

CS SYSTEM REPORTING CODES	ADDRESS 0319-0330		
	LEFT	ADDR	RIGHT
Alarm Restore	blank (•)	0319	
Trouble	blank (•)	0320	
Trouble Restore	blank (•)	0321	
Xmitter Low Battery	blank (•)	0322	
Xmitter Supervision	blank (•)	0323	
Xmitter Tamper	blank (•)	0324	
RESERVED	blank (•)	0325	blank (•)
Opening	blank (•)	0326	
Closing	blank (•)	0327	
Opening after Alarm		0328	
Conditional Close		0329	
Fail to Open		0330	

[Default = blank (•) blank (•) from

address 0319-0330]

CS SYSTEM REPORTING CODES	ADDRESS 0333-0347		
	LEFT	ADDR	RIGHT
Telco Fail		0333	
RF Rec. Trouble		0334	
Memory Fail		0335	
Low Battery		0336	
Panel AC Fail		0337	
EZM Tamper		0338	
Alarm Output Superv.		0339	
Ambush		0340	
Panic		0341	
Fire		0342	
Auxiliary		0343	
Tamper		0344	
Fail to Close		0345	
Test Timer		0346	
Keyfob Low Battery		0347	

CS SYSTEM REPORTING CODES:

1. Enter in corresponding address location (left and right digits). **NOTE:** Left digit is the first digit and right digit is the second digit in a two digit CS receiver format.
 2. Valid entries are: 1-9, 0 and B-F. **NOTE:** A is not permitted.
 3. To disable a code leave boxes blank (•).
- NOTE:** Dark shaded data value box shows option not available.



CS ZONE REPORTING OPTIONS (ADDRESS 0358-0389)

PROGRAMMING OPTIONS & WORKSHEETS

ADDRESS 0358-0365							
CONTROL PANEL ZONES REPORT CODE							
ZONE 1	ZONE 2	ZONE 3	ZONE 4	ZONE 5	ZONE 6	ZONE 7	ZONE 8
0358	0359	0360	0361	0362	0363	0364	0365
L R	L R	L R	L R	L R	L R	L R	L R

ADDRESS 0366-0369			
ZONES REPORT CODE			
ZONE 9	ZONE 10	ZONE 11	ZONE 12
0366	0367	0368	0369
L R	L R	L R	L R

ADDRESS 0370-0373			
ZONES REPORT CODE			
ZONE 13	ZONE 14	ZONE 15	ZONE 16
0370	0371	0372	0373
L R	L R	L R	L R

ADDRESS 0374-0377			
ZONES REPORT CODE			
ZONE 17	ZONE 18	ZONE 19	ZONE 20
0374	0375	0376	0377
L R	L R	L R	L R

ADDRESS 0378-0381			
ZONES REPORT CODE			
ZONE 21	ZONE 22	ZONE 23	ZONE 24
0378	0379	0380	0381
L R	L R	L R	L R

ADDRESS 0382-0385			
ZONES REPORT CODE			
ZONE 25	ZONE 26	ZONE 27	ZONE 28
0382	0383	0384	0385
L R	L R	L R	L R

ADDRESS 0386-0389			
ZONES REPORT CODE			
ZONE 29	ZONE 30	ZONE 31	ZONE 32
0386	0387	0388	0389
L R	L R	L R	L R

Default for Group Zone Report Codes depends on Easy Menu Question "RCVR."

ZONE REPORT CODE OPTIONS	
DATA ENTRIES	
LEFT	RIGHT

NOTE: If "Zone Doubling" (Address 0721) is **not** enabled, then Zones 1-8 are included in the control panel and Zones 9-32 are EZM Zones. If "Zone Doubling" is enabled, then Zones 1-16 are included in the control panel and Zones 17-32 are EZM Zones. See Address 0737-0742 to enable "EZM Zone Groups".

PULSE EVENT CODE will be the first digit of the 2 digit reporting code. the second digit will be the second digit of the reporting zone. For example, for zone 9 (address 0366), if the right digit is "3", then the reporting code is "39". For example, for zone 15 (address 0372), if the right digit is "4", then the reporting code is "45".

DATA ENTRIES	MODEM CODE
LEFT	
1	Fire *
2	Panic
3	Burglary
4	Hold up
7	Gas Alarm
8	Heat Alarm
0	Auxiliary Alarm
B	24 Hour Auxiliary

MODEM CODES determine the zone types reported for the following formats: SIA and ADEMCO Point ID.

1. Select the desired Modem Code for each zone from the table shown.

CS AREA & SYSTEM REPORTING OPTIONS (ADDRESS 0391-0394)

AREA	LEFT DATA VALUES (CIRCLE)
AREA 1	1
AREA 2	2
RESERVED	4
RESERVED	8

DISABLE OPENING REPORTS	
ADDRESS 0391	
LEFT DIGIT (SUM OF DATA VALUES)	RIGHT DIGIT
	blank (*)

[Default = blank (*) blank (*)]

AREA	LEFT DATA VALUES (CIRCLE)
AREA 1	1
AREA 2	2
RESERVED	4
RESERVED	8

DISABLE CLOSING REPORTS	
ADDRESS 0392	
LEFT DIGIT (SUM OF DATA VALUES)	RIGHT DIGIT
	blank (*)

[Default = blank (*) blank (*)]

CS SYSTEM REPORT OPTIONS	LEFT DATA VALUES (CIRCLE)
Cancel Next Test Timer on any Report	1
Disable Wait for Silence	2
Disable Wait for Handshake	4
Disable Dial Tone Detect	8

ADDRESS 0394	
LEFT DIGIT (SUM OF DATA VALUES)	RIGHT DIGIT (SUM OF DATA VALUES)

[Default = blank (*) blank (*)]

RIGHT DATA VALUES (CIRCLE)	CS SYSTEM REPORT OPTIONS
1	Backup Report on Telco 2
2	Touch-tone Dialing Only *
4	Touch-tone Dialing w/Rotary Backup *
8	RESERVED

CS AREA & SYSTEM REPORTING OPTIONS:

1. Select the desired option by circling the data values for each digit (left and right).
2. Add the data values (ex: 15=1+2+4+8) from the selected options.
3. Enter in address location (left and right digits).

NOTE: Dark shaded data value box shows option not available.

* **NOTE:** If neither Touch-tone Dialing nor Touch-tone w/Rotary Backup is selected, then system defaults automatically to Rotary Dialing. Leave blank (*) to select Rotary Dialing.

CS USER REPORTING OPTIONS (ADDRESS 0440-0459)

User Opening Telco 1	LEFT DATA VALUES				ADDRESS 0440		RIGHT DATA VALUES				LEFT DATA VALUES				ADDRESS 0441		RIGHT DATA VALUES			
	User 8	User 7	User 6	User 5	LEFT	RIGHT	User 4	User 3	User 2	User 1	User 16	User 15	User 14	User 13	LEFT	RIGHT	User 12	User 11	User 10	User 9
	8	4	2	1			8	4	2	1	8	4	2	1			8	4	2	1

User Opening Telco 1	LEFT DATA VALUES				ADDRESS 0443		RIGHT DATA VALUES				LEFT DATA VALUES				ADDRESS 0442		RIGHT DATA VALUES			
	User 32	User 31	User 30	User 29	LEFT	RIGHT	User 28	User 27	User 26	User 25	User 24	User 23	User 22	User 21	LEFT	RIGHT	User 20	User 19	User 18	User 17
	8	4	2	1			8	4	2	1	8	4	2	1			8	4	2	1

User Opening Telco 1	ADDRESS 0444		RIGHT DATA VALUES				User 97 = Auto Arming/Disarming User 98 = Quickloader Arming/Disarming User 99 = Easy Arming (Opening not applicable) User 00 = Keyswitch Arming								NOTE: These opening events will report as the user number shown. Also, Keyfobs 1-8 (see Easy Menu Program Driven Mode) will report as Users 25-32, respectively.			
	LEFT	RIGHT	User 00	User 99	User 98	User 97												
	blank (*)		8	4	2	1												

User Closing Telco 1	LEFT DATA VALUES				ADDRESS 0445		RIGHT DATA VALUES				LEFT DATA VALUES				ADDRESS 0446		RIGHT DATA VALUES			
	User 8	User 7	User 6	User 5	LEFT	RIGHT	User 4	User 3	User 2	User 1	User 16	User 15	User 14	User 13	LEFT	RIGHT	User 12	User 11	User 10	User 9
	8	4	2	1			8	4	2	1	8	4	2	1			8	4	2	1

User Closing Telco 1	LEFT DATA VALUES				ADDRESS 0448		RIGHT DATA VALUES				LEFT DATA VALUES				ADDRESS 0447		RIGHT DATA VALUES			
	User 32	User 31	User 30	User 29	LEFT	RIGHT	User 28	User 27	User 26	User 25	User 24	User 23	User 22	User 21	LEFT	RIGHT	User 20	User 19	User 18	User 17
	8	4	2	1			8	4	2	1	8	4	2	1			8	4	2	1

User Closing Telco 1	ADDRESS 0449		RIGHT DATA VALUES				User 97 = Auto Arming/Disarming User 98 = Quickloader Arming/Disarming User 99 = Easy Arming (Opening not applicable) User 00 = Keyswitch Arming								NOTE: These opening events will report as the user number shown. Also, Keyfobs 1-8 (see Easy Menu Program Driven Mode) will report as Users 25-32, respectively.			
	LEFT	RIGHT	User 00	User 99	User 98	User 97												
	blank (*)		8	4	2	1												

User Opening Telco 3	LEFT DATA VALUES				ADDRESS 0450		RIGHT DATA VALUES				LEFT DATA VALUES				ADDRESS 0451		RIGHT DATA VALUES			
	User 8	User 7	User 6	User 5	LEFT	RIGHT	User 4	User 3	User 2	User 1	User 16	User 15	User 14	User 13	LEFT	RIGHT	User 12	User 11	User 10	User 9
	8	4	2	1			8	4	2	1	8	4	2	1			8	4	2	1

User Opening Telco 3	LEFT DATA VALUES				ADDRESS 0453		RIGHT DATA VALUES				LEFT DATA VALUES				ADDRESS 0452		RIGHT DATA VALUES			
	User 32	User 31	User 30	User 29	LEFT	RIGHT	User 28	User 27	User 26	User 25	User 24	User 23	User 22	User 21	LEFT	RIGHT	User 20	User 19	User 18	User 17
	8	4	2	1			8	4	2	1	8	4	2	1			8	4	2	1





User Opening Telco 3	ADDRESS 0454		RIGHT DATA VALUES				User 97 = Auto Arming/Disarming User 98 = Quickloader Arming/Disarming User 99 = Easy Arming (Opening not applicable) User 00 = Keyswitch Arming								NOTE: These opening events will report as the user number shown. Also, Keyfobs 1-8 (see Easy Menu Program Driven Mode) will report as Users 25-32, respectively.			
	LEFT	RIGHT	User 00	User 99	User 98	User 97												
	blank (*)		8	4	2	1												

User Closing Telco 3	LEFT DATA VALUES				ADDRESS 0455		RIGHT DATA VALUES				LEFT DATA VALUES				ADDRESS 0456		RIGHT DATA VALUES			
	User 8	User 7	User 6	User 5	LEFT	RIGHT	User 4	User 3	User 2	User 1	User 16	User 15	User 14	User 13	LEFT	RIGHT	User 12	User 11	User 10	User 9
	8	4	2	1			8	4	2	1	8	4	2	1			8	4	2	1

User Closing Telco 3	LEFT DATA VALUES				ADDRESS 0458		RIGHT DATA VALUES				LEFT DATA VALUES				ADDRESS 0457		RIGHT DATA VALUES			
	User 32	User 31	User 30	User 29	LEFT	RIGHT	User 28	User 27	User 26	User 25	User 24	User 23	User 22	User 21	LEFT	RIGHT	User 20	User 19	User 18	User 17
	8	4	2	1			8	4	2	1	8	4	2	1			8	4	2	1

User Closing Telco 3	ADDRESS 0459		RIGHT DATA VALUES				User 97 = Auto Arming/Disarming User 98 = Quickloader Arming/Disarming User 99 = Easy Arming (Opening not applicable) User 00 = Keyswitch Arming								NOTE: These opening events will report as the user number shown. Also, Keyfobs 1-8 (see Easy Menu Program Driven Mode) will report as Users 25-32, respectively.			
	LEFT	RIGHT	User 00	User 99	User 98	User 97												
	blank (*)		8	4	2	1												

CS USER REPORTING OPTIONS: [Default = blank (*) blank (*) from address 0440-0459]

-  1. Select the desired option by circling  the data values for each digit (left and right).
-  2. Add the data values (ex: 15=1+2+4+8) from the selected options.
-  3. Enter in address location (left and right digits). **NOTE:** Dark shaded data value box shows option not available.

EZM GROUP OPTIONS (ADDRESS 0737-0742)

EZM Group 1	
ADDRESS 0737	
LEFT	RIGHT
blank (*)	

EZM Group 2	
ADDRESS 0738	
LEFT	RIGHT
blank (*)	

EZM Group 3	
ADDRESS 0739	
LEFT	RIGHT
blank (*)	

EZM Group 4	
ADDRESS 0740	
LEFT	RIGHT
blank (*)	

EZM Group 5	
ADDRESS 0741	
LEFT	RIGHT
blank (*)	

EZM Group 6	
ADDRESS 0742	
LEFT	RIGHT
blank (*)	

Default depends on Easy Menu Question “# OF ZNS IN AREA 1 ENTER # ZONES” and “EZ ZONE DOUBLING? Y/N”. For example, If 32 zones are used and Zone Doubling is not enabled, then all 6 groups will be automatically enabled. If 32 zones are used and Zone Doubling is enabled, then only groups 1-4 will be automatically enabled.

NOTE: If “Zone Doubling” (Address 0721) is not enabled, then Zones 1-8 are included in the control panel and Zones 9-32 (Groups 1-6) are EZM Zones. If “Zone Doubling” is enabled, then Zones 1-16 are included in the control panel and Zones 17-32 (Groups 1-4) are EZM Zones and groups 5 and 6 must not be used.

EZM TYPE	
DATA ENTRIES	OPTION
RIGHT	
blank (*)	Not used (No EZM present)
1	4-Zone EZM

EZM TYPE	ZONES COVERED	
	NORMAL	DOUBLED
1	9-12	17-20
2	13-16	21-24
3	17-20	25-28
4	21-24	29-32
5	25-28	
6	29-32	

EZM GROUP OPTIONS: Up to 6 Groups of 4 Zones each may be programmed depending on the number of zones used and which EZM modules are connected. Each group represents 4 zones.

1. Select EZM type from the table shown.
2. Enter in corresponding address locations above (right digit only).

NOTE: Dark shaded data value box shows option not available.

AREA ARMING OPTIONS (ADDRESS 0743 & 0744)

Priority Arming/ Area 1 ADDRESS 0743		
LEFT	RIGHT	
blank (*)		

[Default = blank (*) blank (*)]

Priority Arming/ Area 2 ADDRESS 0744		
LEFT	RIGHT	
blank (*)		

[Default = blank (*) blank (*)]

PRIORITY AREA ARMING:

1. Select option from the table shown.
2. Enter in corresponding right digit address location (left digit is not used).

NOTE: Dark shaded data value box shows option not available.

PRIORITY ARMING/AREA 1		
DATA ENTRIES		OPTION
LEFT	RIGHT	
blank (*)	blank (*)	Not Used
blank (*)	2	Enabled

PRIORITY ARMING/AREA 2		
DATA ENTRIES		OPTION
LEFT	RIGHT	
blank (*)	blank (*)	Not Used
blank (*)	1	Enabled

AREA BELL CONTROL OPTIONS (ADDRESS 0745 & 0746)



<table border="1" style="width: 100%; border-collapse: collapse;"> <tr><th colspan="2" style="text-align: center;">Disarming Area 2</th></tr> <tr><th style="width: 50%;">LEFT DATA VALUES (CIRCLE)</th><th style="width: 50%;"> </th></tr> <tr><td style="text-align: center;">Area 1 Burg Output Silenced</td><td style="text-align: center;">1</td></tr> <tr><td style="text-align: center;">Area 2 Burg Output Silenced</td><td style="text-align: center;">2</td></tr> <tr><td style="text-align: center;">RESERVED</td><td style="text-align: center;">4</td></tr> <tr><td style="text-align: center;">RESERVED</td><td style="text-align: center;">8</td></tr> </table>	Disarming Area 2		LEFT DATA VALUES (CIRCLE)		Area 1 Burg Output Silenced	1	Area 2 Burg Output Silenced	2	RESERVED	4	RESERVED	8	<table border="1" style="width: 100%; border-collapse: collapse;"> <tr><th colspan="2" style="text-align: center;">Burglary Output Turns Off upon Disarm ADDRESS 0745</th></tr> <tr><th style="width: 50%;">LEFT DIGIT (SUM OF DATA VALUES)</th><th style="width: 50%;">RIGHT DIGIT (SUM OF DATA VALUES)</th></tr> <tr><td style="text-align: center;"> </td><td style="text-align: center;"> </td></tr> </table> <p>[Default = blank (*) blank (*)]</p>	Burglary Output Turns Off upon Disarm ADDRESS 0745		LEFT DIGIT (SUM OF DATA VALUES)	RIGHT DIGIT (SUM OF DATA VALUES)			<table border="1" style="width: 100%; border-collapse: collapse;"> <tr><th colspan="2" style="text-align: center;">Disarming Area 1</th></tr> <tr><th style="width: 50%;">RIGHT DATA VALUES (CIRCLE)</th><th style="width: 50%;"> </th></tr> <tr><td style="text-align: center;">1</td><td style="text-align: center;">Area 1 Burg Output Silenced</td></tr> <tr><td style="text-align: center;">2</td><td style="text-align: center;">Area 2 Burg Output Silenced</td></tr> <tr><td style="text-align: center;">4</td><td style="text-align: center;">RESERVED</td></tr> <tr><td style="text-align: center;">8</td><td style="text-align: center;">RESERVED</td></tr> </table>	Disarming Area 1		RIGHT DATA VALUES (CIRCLE)		1	Area 1 Burg Output Silenced	2	Area 2 Burg Output Silenced	4	RESERVED	8	RESERVED
Disarming Area 2																																
LEFT DATA VALUES (CIRCLE)																																
Area 1 Burg Output Silenced	1																															
Area 2 Burg Output Silenced	2																															
RESERVED	4																															
RESERVED	8																															
Burglary Output Turns Off upon Disarm ADDRESS 0745																																
LEFT DIGIT (SUM OF DATA VALUES)	RIGHT DIGIT (SUM OF DATA VALUES)																															
Disarming Area 1																																
RIGHT DATA VALUES (CIRCLE)																																
1	Area 1 Burg Output Silenced																															
2	Area 2 Burg Output Silenced																															
4	RESERVED																															
8	RESERVED																															



<table border="1" style="width: 100%; border-collapse: collapse;"> <tr><th colspan="2" style="text-align: center;">Disarming Area 2</th></tr> <tr><th style="width: 50%;">LEFT DATA VALUES (CIRCLE)</th><th style="width: 50%;"> </th></tr> <tr><td style="text-align: center;">Area 1 Pulsed Burg Output Silenced</td><td style="text-align: center;">1</td></tr> <tr><td style="text-align: center;">Area 2 Pulsed Burg Output Silenced</td><td style="text-align: center;">2</td></tr> <tr><td style="text-align: center;">RESERVED</td><td style="text-align: center;">4</td></tr> <tr><td style="text-align: center;">RESERVED</td><td style="text-align: center;">8</td></tr> </table>	Disarming Area 2		LEFT DATA VALUES (CIRCLE)		Area 1 Pulsed Burg Output Silenced	1	Area 2 Pulsed Burg Output Silenced	2	RESERVED	4	RESERVED	8	<table border="1" style="width: 100%; border-collapse: collapse;"> <tr><th colspan="2" style="text-align: center;">Pulsed Burg Output Turns Off upon Disarm ADDRESS 0746</th></tr> <tr><th style="width: 50%;">LEFT DIGIT (SUM OF DATA VALUES)</th><th style="width: 50%;">RIGHT DIGIT (SUM OF DATA VALUES)</th></tr> <tr><td style="text-align: center;"> </td><td style="text-align: center;"> </td></tr> </table> <p>[Default = blank (*) blank (*)]</p>	Pulsed Burg Output Turns Off upon Disarm ADDRESS 0746		LEFT DIGIT (SUM OF DATA VALUES)	RIGHT DIGIT (SUM OF DATA VALUES)			<table border="1" style="width: 100%; border-collapse: collapse;"> <tr><th colspan="2" style="text-align: center;">Disarming Area 1</th></tr> <tr><th style="width: 50%;">RIGHT DATA VALUES (CIRCLE)</th><th style="width: 50%;"> </th></tr> <tr><td style="text-align: center;">1</td><td style="text-align: center;">Area 1 Pulsed Burg Output Silenced</td></tr> <tr><td style="text-align: center;">2</td><td style="text-align: center;">Area 2 Pulsed Burg Output Silenced</td></tr> <tr><td style="text-align: center;">4</td><td style="text-align: center;">RESERVED</td></tr> <tr><td style="text-align: center;">8</td><td style="text-align: center;">RESERVED</td></tr> </table>	Disarming Area 1		RIGHT DATA VALUES (CIRCLE)		1	Area 1 Pulsed Burg Output Silenced	2	Area 2 Pulsed Burg Output Silenced	4	RESERVED	8	RESERVED
Disarming Area 2																																
LEFT DATA VALUES (CIRCLE)																																
Area 1 Pulsed Burg Output Silenced	1																															
Area 2 Pulsed Burg Output Silenced	2																															
RESERVED	4																															
RESERVED	8																															
Pulsed Burg Output Turns Off upon Disarm ADDRESS 0746																																
LEFT DIGIT (SUM OF DATA VALUES)	RIGHT DIGIT (SUM OF DATA VALUES)																															
Disarming Area 1																																
RIGHT DATA VALUES (CIRCLE)																																
1	Area 1 Pulsed Burg Output Silenced																															
2	Area 2 Pulsed Burg Output Silenced																															
4	RESERVED																															
8	RESERVED																															

OUTPUT TURNS OFF UPON DISARM: Select options for any of the 4 Outputs.





1. Select the desired option by circling the data values for right digit only (left is not used).
2. Add the data values (ex: 15=1+2+4+8) from the selected options.
3. Enter in right digit address location. **NOTE:** Dark shaded data value box shows option not available.

AREA BELL CONTROL OPTIONS (ADDRESS 0747 & 0749)

Disarming Area 2	LEFT DATA VALUES (CIRCLE )	PGM1 Output Turns Off upon Disarm ADDRESS 0747	RIGHT DATA VALUES (CIRCLE )	Disarming Area 1
Area 1 PGM1 Output Silenced	1	LEFT DIGIT (SUM OF DATA VALUES)	1	Area 1 PGM1 Output Silenced
Area 2 PGM1 Output Silenced	2	RIGHT DIGIT (SUM OF DATA VALUES)	2	Area 2 PGM1 Output Silenced
RESERVED	4		4	RESERVED
RESERVED	8		8	RESERVED
[Default = blank (•) blank (•)]				

Disarming Area 2	LEFT DATA VALUES (CIRCLE )	PGM2 Output Turns Off upon Disarm ADDRESS 0749	RIGHT DATA VALUES (CIRCLE )	Disarming Area 1
Area 1 PGM2 Output Silenced	1	LEFT DIGIT (SUM OF DATA VALUES)	1	Area 1 PGM2 Output Silenced
Area 2 PGM2 Output Silenced	2	RIGHT DIGIT (SUM OF DATA VALUES)	2	Area 2 PGM2 Output Silenced
RESERVED	4		4	RESERVED
RESERVED	8		8	RESERVED
[Default = blank (•) blank (•)]				

OUTPUT TURNS OFF UPON DISARM: Select options for any of the 4 Outputs.

-  1. Select the desired option by circling  the data values for right digit only (left is not used).
-  2. Add the data values (ex: 15=1+2+4+8) from the selected options.
-  3. Enter in right digit address location. **NOTE:** Dark shaded data value box shows option not available.



KEYPAD OPTIONS (ADDRESS 0723-0736)

Keypad 1 Area Assignment	ADDRESS 0723	LEFT	RIGHT	Keypad 2 Area Assignment	ADDRESS 0724	LEFT	RIGHT	Keypad 3 Area Assignment	ADDRESS 0725	LEFT	RIGHT	Keypad 4 Area Assignment	ADDRESS 0726	LEFT	RIGHT
		blank (•)				blank (•)				blank (•)				blank (•)	
		[Default = blank (•) 1]				[Default = blank (•) 1]				[Default = blank (•) 1]				[Default = blank (•) 1]	



Keypad 5 Area Assignment	ADDRESS 0727	LEFT	RIGHT	Keypad 6 Area Assignment	ADDRESS 0728	LEFT	RIGHT	Keypad 7 Area Assignment	ADDRESS 0729	LEFT	RIGHT
		blank (•)				blank (•)				blank (•)	
		[Default = blank (•) 1]				[Default = blank (•) 1]				[Default = blank (•) 1]	

KEYPAD AREA ASSIGNMENT: Up to 7 keypads may be programmed, if they are connected.

NOTE: Keypad Number is configured by setting its jumper settings. By default from the factory, each keypad is configured as number 1.





-  1. Select area assignment for each keypad from the table shown.
 -  2. Enter in corresponding right digit address locations above (left digit is not used).
- NOTE:** Dark shaded data value box shows option not available.

KEYPAD AREA ASSIGNMENT		
DATA ENTRIES		OPTION
LEFT	RIGHT	
blank (•)	1	Area 1
blank (•)	2	Area 2

KEYPAD NO.	KEYPAD OPTIONS				ADDRESS 0730-0736			KEYPAD OPTIONS			
	LEFT DATA VALUES (CIRCLE )				LEFT	ADDR	RIGHT	RIGHT DATA VALUES (CIRCLE )			
	RSRVD	PANEL ACCESS	EASY ARMING	AMBUSH				RSRVD	KEYPAD PANIC	KEYPAD AUXILIARY	KEYPAD FIRE
1	8	4	2	1	0730	8	4	2	1		
2	8	4	2	1	0731	8	4	2	1		
3	8	4	2	1	0732	8	4	2	1		
4	8	4	2	1	0733	8	4	2	1		
5	8	4	2	1	0734	8	4	2	1		
6	8	4	2	1	0735	8	4	2	1		
7	8	4	2	1	0736	8	4	2	1		

[Default = blank (•) blank (•) from address 0730-0736]

KEYPAD OPTIONS: Select options for any of the 7 keypads.

-  1. Select the desired option by circling  the data values for each digit (left and right).
-  2. Add the data values (ex: 15=1+2+4+8) from the selected options.
-  3. Enter in address location (left and right digits). **NOTE:** Dark shaded data value box shows option not available.

ZONE OPTIONS - ZONES 1 TO 16 (ADDRESS 0490-0592)

PROGRAMMING OPTIONS & WORKSHEETS

ZONE OPTIONS	ZONES 13-16 LEFT DATA VALUES (CIRCLE)				ADDRESS 0546-0592			ZONES 9-12 RIGHT DATA VALUES (CIRCLE)				ZONES 5-8 LEFT DATA VALUES (CIRCLE)				ADDRESS 0490-0537			ZONES 1-4 RIGHT DATA VALUES (CIRCLE)			
	ZN16	ZN15	ZN14	ZN13	L	ADDR	R	ZN12	ZN11	ZN10	ZN9	ZN8	ZN7	ZN6	ZN5	L	ADDR	R	ZN4	ZN3	ZN2	ZN1
	8	4	2	1				8	4	2	1	8	4	2	1		0490		8	4	2	1
50ms Loop Response (A)	8	4	2	1				8	4	2	1	8	4	2	1		0490		8	4	2	1
✓ Priority	8	4	2	1		0546		8	4	2	1	8	4	2	1		0491		8	4	2	1
Priority with Bypass	8	4	2	1		0547		8	4	2	1	8	4	2	1		0492		8	4	2	1
Auto-Bypass	8	4	2	1		0548		8	4	2	1	8	4	2	1		0493		8	4	2	1
✓ Selective Bypass	8	4	2	1		0549		8	4	2	1	8	4	2	1		0494		8	4	2	1
Keyswitch Arming	8	4	2	1		0550		8	4	2	1	8	4	2	1		0495		8	4	2	1
Auto-Bypass Re-entry	8	4	2	1		0551		8	4	2	1	8	4	2	1		0496		8	4	2	1
Pre-Alarm Warning	8	4	2	1		0552		8	4	2	1	8	4	2	1		0497		8	4	2	1
Never Arm	8	4	2	1		0553		8	4	2	1	8	4	2	1		0498		8	4	2	1
24-Hour Zone	8	4	2	1		0554		8	4	2	1	8	4	2	1		0499		8	4	2	1
✓ Alarm Output	8	4	2	1		0555		8	4	2	1	8	4	2	1		0500		8	4	2	1
✓ Pulsed Alarm Output	8	4	2	1		0556		8	4	2	1	8	4	2	1		0501		8	4	2	1
PGM1 Output	8	4	2	1		0557		8	4	2	1	8	4	2	1		0502		8	4	2	1
PGM2 Output	8	4	2	1		0558		8	4	2	1	8	4	2	1		0503		8	4	2	1
✓ Entry/Exit 1	8	4	2	1		0559		8	4	2	1	8	4	2	1		0504		8	4	2	1
Entry/Exit 2	8	4	2	1		0560		8	4	2	1	8	4	2	1		0505		8	4	2	1
Exit/Entry Follower	8	4	2	1		0561		8	4	2	1	8	4	2	1		0506		8	4	2	1
✓ Auto Reset	8	4	2	1		0562		8	4	2	1	8	4	2	1		0507		8	4	2	1
Swinger Shutdown	8	4	2	1		0563		8	4	2	1	8	4	2	1		0508		8	4	2	1
✓ Chime	8	4	2	1		0564		8	4	2	1	8	4	2	1		0509		8	4	2	1
Abort Delay	8	4	2	1		0565		8	4	2	1	8	4	2	1		0510		8	4	2	1
Power-up Delay	8	4	2	1		0566		8	4	2	1	8	4	2	1		0511		8	4	2	1
Day Zone Open	8	4	2	1		0567		8	4	2	1	8	4	2	1		0512		8	4	2	1
Day Zone Short	8	4	2	1		0568		8	4	2	1	8	4	2	1		0513		8	4	2	1
Alarm on Day Zone	8	4	2	1		0569		8	4	2	1	8	4	2	1		0514		8	4	2	1
✓ Alarm Telco 1	8	4	2	1		0570		8	4	2	1	8	4	2	1		0515		8	4	2	1
Alarm Restore 1	8	4	2	1		0571		8	4	2	1	8	4	2	1		0516		8	4	2	1
Trouble Telco 1	8	4	2	1		0572		8	4	2	1	8	4	2	1		0517		8	4	2	1
Trouble Restore 1	8	4	2	1		0573		8	4	2	1	8	4	2	1		0518		8	4	2	1
Alarm Telco 3	8	4	2	1		0574		8	4	2	1	8	4	2	1		0519		8	4	2	1
Alarm Restore 3	8	4	2	1		0575		8	4	2	1	8	4	2	1		0520		8	4	2	1
Trouble Telco 3	8	4	2	1		0576		8	4	2	1	8	4	2	1		0521		8	4	2	1
Trouble Restore 3	8	4	2	1		0577		8	4	2	1	8	4	2	1		0522		8	4	2	1
No EOL Resistor	8	4	2	1		0578		8	4	2	1	8	4	2	1		0523		8	4	2	1
Trouble on Open	8	4	2	1		0579		8	4	2	1	8	4	2	1		0524		8	4	2	1
Trouble on Short	8	4	2	1		0580		8	4	2	1	8	4	2	1		0525		8	4	2	1
✓ Zone Area 1	8	4	2	1		0581		8	4	2	1	8	4	2	1		0526		8	4	2	1
Zone Area 2	8	4	2	1		0582		8	4	2	1	8	4	2	1		0527		8	4	2	1
✓ Interior Bypass	8	4	2	1		0583		8	4	2	1	8	4	2	1		0528		8	4	2	1
Keypad Sounder on Alarm	8	4	2	1		0584		8	4	2	1	8	4	2	1		0529		8	4	2	1
✓ 2-Wire Smoke Detectors (B)	8	4	2	1	(+)	0585	(+)	8	4	2	1	8	4	2	1		0530	(-)	8	4	2	1
✓ Fire (C)	8	4	2	1		0586		8	4	2	1	8	4	2	1		0531		8	4	2	1
Fire Alarm Verification (C)	8	4	2	1		0587		8	4	2	1	8	4	2	1		0532		8	4	2	1
RESERVED	8	4	2	1	(+)	0588	(+)	8	4	2	1	8	4	2	1	(+)	0533	(+)	8	4	2	1
Zone ANDing Group 1	8	4	2	1		0589		8	4	2	1	8	4	2	1		0534		8	4	2	1
Zone ANDing Group 2	8	4	2	1		0590		8	4	2	1	8	4	2	1		0535		8	4	2	1
Zone ANDing Group 3	8	4	2	1		0591		8	4	2	1	8	4	2	1		0536		8	4	2	1
Zone ANDing Group 4	8	4	2	1		0592		8	4	2	1	8	4	2	1		0537		8	4	2	1

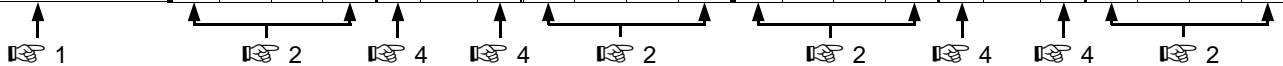

1. **Select** the desired zone option.

ZONE OPTIONS
50ms Loop Response
Priority
Priority with Bypass
Auto-Bypass
Selective Bypass

2. **Enable** desired options for each zone by drawing a circle around its corresponding binary data value.

NOTE: No circle = feature disabled.

ZN04	ZN03	ZN02	ZN01
8	4	2	1

Draw Circle around the '1' in ZN01.

3. **Search table** below for data entry.

DIGIT VALUE	DATA ENTRY	DIGIT VALUE	DATA ENTRY
8 4 2 1	Blank (+)	8 4 2 1	8
8 4 2 ①	1	8 4 2 ①	9
8 4 ② 1	2	8 4 ② 1	0
8 4 ③ 1	3	8 4 ③ 1	B
8 ④ 2 1	4	8 ④ 2 1	C
8 ④ 2 ①	5	8 ④ 2 ①	D
8 ④ ② 1	6	8 ④ ② 1	E
8 ④ ② ①	7	8 ④ ② ①	F

4. **Enter data** in address locations (left and right digits).

ADDRESS LOCATION		
L	ADDR	R
blank (+)	0490	1

NOTE: Dark shaded data value box shows option not available.

NOTE: See Direct Address Programming Example on page 20.

ZONE OPTIONS - ZONES 17 TO 32 (ADDRESS 0601-0702)

PROGRAMMING OPTIONS & WORKSHEETS

ZONE OPTIONS	ZONES 29-32 LEFT DATA VALUES (CIRCLE)				ADDRESS 0656-0702			ZONES 25-28 RIGHT DATA VALUES (CIRCLE)				ZONES 21-24 LEFT DATA VALUES (CIRCLE)				ADDRESS 0601-0647			ZONES 17-20 RIGHT DATA VALUES (CIRCLE)			
	ZN32	ZN31	ZN30	ZN29	L	ADDR	R	ZN28	ZN27	ZN26	ZN25	ZN24	ZN23	ZN22	ZN21	L	ADDR	R	ZN20	ZN19	ZN18	ZN17
	8	4	2	1				8	4	2	1	8	4	2	1				8	4	2	1
50ms Loop Response (A)	8	4	2	1				8	4	2	1	8	4	2	1				8	4	2	1
✓ Priority	8	4	2	1		0656		8	4	2	1	8	4	2	1		0601		8	4	2	1
Priority with Bypass	8	4	2	1		0657		8	4	2	1	8	4	2	1		0602		8	4	2	1
Auto-Bypass	8	4	2	1		0658		8	4	2	1	8	4	2	1		0603		8	4	2	1
✓ Selective Bypass	8	4	2	1		0659		8	4	2	1	8	4	2	1		0604		8	4	2	1
Keyswitch Arming	8	4	2	1		0660		8	4	2	1	8	4	2	1		0605		8	4	2	1
Auto-Bypass Re-entry	8	4	2	1		0661		8	4	2	1	8	4	2	1		0606		8	4	2	1
Pre-Alarm Warning	8	4	2	1		0662		8	4	2	1	8	4	2	1		0607		8	4	2	1
Never Arm	8	4	2	1		0663		8	4	2	1	8	4	2	1		0608		8	4	2	1
24-Hour Zone	8	4	2	1		0664		8	4	2	1	8	4	2	1		0609		8	4	2	1
✓ Alarm Output	8	4	2	1		0665		8	4	2	1	8	4	2	1		0610		8	4	2	1
✓ Pulsed Alarm Output	8	4	2	1		0666		8	4	2	1	8	4	2	1		0611		8	4	2	1
PGM1 Output	8	4	2	1		0667		8	4	2	1	8	4	2	1		0612		8	4	2	1
PGM2 Output	8	4	2	1		0668		8	4	2	1	8	4	2	1		0613		8	4	2	1
✓ Entry/Exit 1	8	4	2	1		0669		8	4	2	1	8	4	2	1		0614		8	4	2	1
Entry/Exit 2	8	4	2	1		0670		8	4	2	1	8	4	2	1		0615		8	4	2	1
✓ Exit/Entry Follower	8	4	2	1		0671		8	4	2	1	8	4	2	1		0616		8	4	2	1
✓ Auto Reset	8	4	2	1		0672		8	4	2	1	8	4	2	1		0617		8	4	2	1
✓ Swinger Shutdown	8	4	2	1		0673		8	4	2	1	8	4	2	1		0618		8	4	2	1
✓ Chime	8	4	2	1		0674		8	4	2	1	8	4	2	1		0619		8	4	2	1
Abort Delay	8	4	2	1		0675		8	4	2	1	8	4	2	1		0620		8	4	2	1
Power-up Delay	8	4	2	1		0676		8	4	2	1	8	4	2	1		0621		8	4	2	1
Day Zone Open	8	4	2	1		0677		8	4	2	1	8	4	2	1		0622		8	4	2	1
Day Zone Short	8	4	2	1		0678		8	4	2	1	8	4	2	1		0623		8	4	2	1
Alarm on Day Zone	8	4	2	1		0679		8	4	2	1	8	4	2	1		0624		8	4	2	1
✓ Alarm Telco 1	8	4	2	1		0680		8	4	2	1	8	4	2	1		0625		8	4	2	1
Alarm Restore 1	8	4	2	1		0681		8	4	2	1	8	4	2	1		0626		8	4	2	1
Trouble Telco 1	8	4	2	1		0682		8	4	2	1	8	4	2	1		0627		8	4	2	1
Trouble Restore 1	8	4	2	1		0683		8	4	2	1	8	4	2	1		0628		8	4	2	1
Alarm Telco 3	8	4	2	1		0684		8	4	2	1	8	4	2	1		0629		8	4	2	1
Alarm Restore 3	8	4	2	1		0685		8	4	2	1	8	4	2	1		0630		8	4	2	1
Trouble Telco 3	8	4	2	1		0686		8	4	2	1	8	4	2	1		0631		8	4	2	1
Trouble Restore 3	8	4	2	1		0687		8	4	2	1	8	4	2	1		0632		8	4	2	1
No EOL Resistor	8	4	2	1		0688		8	4	2	1	8	4	2	1		0633		8	4	2	1
Trouble on Open	8	4	2	1		0689		8	4	2	1	8	4	2	1		0634		8	4	2	1
Trouble on Short	8	4	2	1		0690		8	4	2	1	8	4	2	1		0635		8	4	2	1
✓ Zone Area 1	8	4	2	1		0691		8	4	2	1	8	4	2	1		0636		8	4	2	1
✓ Zone Area 2	8	4	2	1		0692		8	4	2	1	8	4	2	1		0637		8	4	2	1
✓ Interior Bypass	8	4	2	1		0693		8	4	2	1	8	4	2	1		0638		8	4	2	1
Keypad Sounder on Alarm	8	4	2	1		0694		8	4	2	1	8	4	2	1		0639		8	4	2	1
✓ 2-Wire Smoke Detectors (B)	8	4	2	1	(•)	0695	(•)	8	4	2	1	8	4	2	1	(•)	0640	(•)	8	4	2	1
✓ Fire (C)	8	4	2	1		0696		8	4	2	1	8	4	2	1		0641		8	4	2	1
Fire Alarm Verification (C)	8	4	2	1		0697		8	4	2	1	8	4	2	1		0642		8	4	2	1
RESERVED	8	4	2	1	(•)	0698	(•)	8	4	2	1	8	4	2	1	(•)	0643	(•)	8	4	2	1
Zone ANDing Group 1	8	4	2	1		0699		8	4	2	1	8	4	2	1		0644		8	4	2	1
Zone ANDing Group 2	8	4	2	1		0700		8	4	2	1	8	4	2	1		0645		8	4	2	1
Zone ANDing Group 3	8	4	2	1		0701		8	4	2	1	8	4	2	1		0646		8	4	2	1
Zone ANDing Group 4	8	4	2	1		0702		8	4	2	1	8	4	2	1		0647		8	4	2	1

NOTES: (A) 50ms Loop Response only available for zones 1-8.
 (B) 2-wire Smoke Detectors only available for zones 7 & 8. (Address Location 0530 can only be programmed as "blank (•) blank (•)", "4 blank (•)", "8 blank (•)" or "C blank (•)".)
 (C) If Fire Alarm Verification is selected, then Fire must also be selected.

DEFAULTS: The zone options indicated are automatically set after exiting the Easy Menu Driven Mode.

- ✓ Priority, Selective Bypass, Alarm Output, Auto Reset, Swinger Shutdown and Zone Area 1 are enabled for the total number of zones entered in "# OF ZONES IN AREA ENTER # ZONES".
- ✓ Alarm Telco 1 is enabled for the zone number(s) entered in "REPORT ALL ZONES TO CENTRAL ZONES? Y/N".
- ✓ Entry/Exit 1 and Chime are enabled for the zone number(s) entered in "ENTRY/EXIT ZONES ENTER ZONE #".
- ✓ Exit/Entry Follower and Interior Bypass are enabled for the zone number(s) entered in "INTERIOR ZONES ENTER ZONE #".
- ✓ Pulse Alarm Output is enabled for the zone number(s) entered in "FIRE ZONES ENTER ZONE #" or "2-WIRE FIRE ZNS ENTER ZONE #".
- ✓ Fire is enabled for the zone number(s) entered in "FIRE ZONES ENTER ZONE #".

RF RECEIVER & SUPERVISORY TIMER OPTIONS (ADDRESS 1038-1053 & 1180)

PROGRAMMING OPTIONS & WORKSHEETS

Number of RF Receivers	ADDRESS 1180		DATA ENTRIES	RF Receiver(s)
	LEFT	RIGHT		
		blank (*)		RIGHT
	blank (*)		blank (*)	None
	blank (*)		1	1
	blank (*)		2	2

Default for Number of Receivers depends on Easy Menu Question for RF Transmitters.

RF RECEIVERS: Up to 2 RF Receivers may be programmed. **NOTE:** This adds wireless capability to the system, increasing up to 32 the number of zones. Also, the corresponding EZM Group Number must be enabled (see address 0737-0742).

1. Select the number of receivers from the table shown.
2. Enter in corresponding right digit address location shown (left digit is not used).

RF SUPERVISORY TIMER	RF TRANSMITTER	ADDRESS 1038-1045		
		LEFT	ADDR	RIGHT
Type 0	Window/Door, 2 Pt.		1038	
Type 1	Window/Door, 2 Pt.		1039	
Type 2	Window/Door, 2 Pt.		1040	
Type 3	Window/Door, 2 Pt.		1041	
Type 4	Window/Door, 4 Pt.		1042	
Type 5	PIR		1043	
Type 6	PIR		1044	
Type 7	Smoke Detector		1045	

[Default = blank (*) blank (*) from address 1038-1045]

RF SUPERVISORY TIMER	RF TRANSMITTER	ADDRESS 1046-1053		
		LEFT	ADDR	RIGHT
Type 8	Smoke Detector		1046	
Type 9	Keyfob		1047	
Type A	Dual Tech.		1048	
Type B	Keyfob		1049	
Type C	Window/Door, 4 Pt.		1050	
Type D	PIR		1051	
Type E	Smoke Detector		1052	
Type F	Napco Glass Break		1053	

[Default = blank (*) blank (*) from address 1046-1053]

RF SUPERVISORY TIMERS		
DATA ENTRIES		DELAY
LEFT	RIGHT	
blank (*)	blank (*)	0 min.
blank (*)	1	30 min.
blank (*)	2	60 min.
blank (*)	3	90 min.
blank (*)	4	120 min.
blank (*)	5	150 min.
blank (*)	6	180 min.
blank (*)	7	210 min.
blank (*)	8	240 min.
blank (*)	9	270 min.
blank (*)	0	300 min.
blank (*)	B	330 min.
blank (*)	C	360 min.
blank (*)	D	390 min.
blank (*)	E	420 min.
blank (*)	F	450 min.
1	blank (*)	480 min.
1	1	510 min.
1	2	540 min.
1	3	570 min.
1	4	600 min.
1	5	630 min.
1	6	660 min.
1	7	690 min.
1	8	720 min.
1	9	750 min.
1	0	780 min.
1	B	810 min.
1	C	840 min.
1	D	870 min.
1	E	900 min.
1	F	930 min.
2	blank (*)	960 min.
2	1	990 min.
2	2	1020 min.
2	3	1050 min.
2	4	1080 min.
2	5	1110 min.

RF SUPERVISORY TIMERS		
DATA ENTRIES		DELAY
LEFT	RIGHT	
2	6	1140 min.
2	7	1170 min.
2	8	1200 min.
2	9	1230 min.
2	0	1260 min.
2	B	1290 min.
2	C	1320 min.
2	D	1350 min.
2	E	1380 min.
2	F	1410 min.
3	blank (*)	1440 min.
3	1	1470 min.
3	2	1500 min.
3	3	1530 min.
3	4	1560 min.
3	5	1590 min.
3	6	1620 min.
3	7	1650 min.
3	8	1680 min.
3	9	1710 min.
3	0	1740 min.
3	B	1770 min.
3	C	1800 min.
3	D	1830 min.
3	E	1860 min.
3	F	1890 min.
4	blank (*)	1920 min.
4	1	1950 min.
4	2	1980 min.
4	3	2010 min.
4	4	2040 min.
4	5	2070 min.
4	6	2100 min.
↓	↓	↓
F	F	7650 min. = 127 Hr., 30 min.

RF SUPERVISORY TIMERS: RF Supervisory Timers may be programmed for each type of transmitter used. A transmitter will send a transmission every time it is tripped, when there is NO activity, the transmitter sends a status transmission about once an hour. If the receiver does NOT receive ANY signal (a trip or a status) from a transmitter in the time specified for transmitter type, a system trouble "RF SUPERVISORY FAILURE" will be displayed at the keypad.

1. Select timer delay from the table shown. Timers are programmed in increments of 30 minutes each. Valid entries are 03-FF, 90 minutes-7650min (127hr,30min).

WARNING: Timers have uncertainty of +0/-30 minutes. Do not use entries 0-2 (shaded areas).

2. Enter in corresponding address locations above (left and right digits).
3. For a desired *timer not* listed do the following:
 - A. Choose a desired timer (intervals of 30), ex: 3000 min. (50 Hours)
 - B. Divide it by 30, ex: 3000/30 = 100
 - C. Divide it by 16

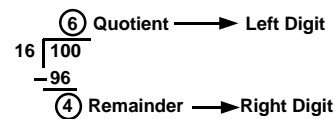

NOTE: These timers apply only to Supervised RF Transmitters (see RF Transmitters in Easy Menu Driven Mode Programming).

EXTERNAL RELAY CONTROL (ADDRESS 0750-0829)

ADDRESS 0750-0754 (RELAY EVENT 1)									
0750		0751		0752		0753		0754	
L	R	L	R	L	R	L	R	L	R
(*)		(*)							

ADDRESS 0755-0759 (RELAY EVENT 2)									
0755		0756		0757		0758		0759	
L	R	L	R	L	R	L	R	L	R
(*)		(*)							

ADDRESS 0760-0764 (RELAY EVENT 3)									
0760		0761		0762		0763		0764	
L	R	L	R	L	R	L	R	L	R
(*)		(*)							

ADDRESS 0765-0769 (RELAY EVENT 4)									
0765		0766		0767		0768		0769	
L	R	L	R	L	R	L	R	L	R
(*)		(*)							

ADDRESS 0770-0774 (RELAY EVENT 5)									
0770		0771		0772		0773		0774	
L	R	L	R	L	R	L	R	L	R
(*)		(*)							

ADDRESS 0775-0779 (RELAY EVENT 6)									
0775		0776		0777		0778		0779	
L	R	L	R	L	R	L	R	L	R
(*)		(*)							

ADDRESS 0780-0784 (RELAY EVENT 7)									
0780		0781		0782		0783		0784	
L	R	L	R	L	R	L	R	L	R
(*)		(*)							

ADDRESS 0785-0789 (RELAY EVENT 8)									
0785		0786		0787		0788		0789	
L	R	L	R	L	R	L	R	L	R
(*)		(*)							

ADDRESS 0790-0794 (RELAY EVENT 9)									
0790		0791		0792		0793		0794	
L	R	L	R	L	R	L	R	L	R
(*)		(*)							

ADDRESS 0795-0799 (RELAY EVENT 10)									
0795		0796		0797		0798		0799	
L	R	L	R	L	R	L	R	L	R
(*)		(*)							

ADDRESS 0800-0804 (RELAY EVENT 11)									
0800		0801		0802		0803		0804	
L	R	L	R	L	R	L	R	L	R
(*)		(*)							

ADDRESS 0805-0809 (RELAY EVENT 12)									
0805		0806		0807		0808		0809	
L	R	L	R	L	R	L	R	L	R
(*)		(*)							

ADDRESS 0810-0814 (RELAY EVENT 13)									
0810		0811		0812		0813		0814	
L	R	L	R	L	R	L	R	L	R
(*)		(*)							

ADDRESS 0815-0819 (RELAY EVENT 14)									
0815		0816		0817		0818		0819	
L	R	L	R	L	R	L	R	L	R
(*)		(*)							

ADDRESS 0820-0824 (RELAY EVENT 15)									
0820		0821		0822		0823		0824	
L	R	L	R	L	R	L	R	L	R
(*)		(*)							

ADDRESS 0825-0829 (RELAY EVENT 16)									
0825		0826		0827		0828		0829	
L	R	L	R	L	R	L	R	L	R
(*)		(*)							

[Default = blank (*) blank (*) from address 0750-0829]

RELAY # OPTIONS: Each relay event can be assigned to any of the 8 available external relays from Relay Module RM3008. Multiple relay events can drive the same External Relay.

1. Select the relay from the table shown; enter in corresponding right digit address location (left digit is not used).

DATA ENTRY RIGHT	RELAY #
blank (*)	NONE
1	1
2	2
3	3
4	4
5	5
6	6
7	7
8	8

RELAY EVENT OPTIONS									
RELAY #		AREA		Timeout		Event ID		COND.	
L	R	L	R	L	R	L	R	L	R
(*)		(*)							

AREA OPTIONS: Each relay event can be assigned to Area 1, Area 2 or both Area 1 & Area 2.

2. Select the area from the table shown; enter in corresponding right digit address location (left digit is not used).

DATA ENTRY RIGHT	OFF/ON AREA DISARM
blank (*)	NONE
1	Area 1
2	Area 2
3	Area 1 & Area 2

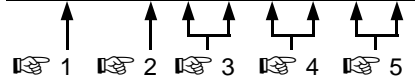

TIMEOUTS: Each relay event can be assigned a timeout depending on Alarm Type option.

3. If Alarm Type (see next page) is selected for timeout in minutes or seconds, select the timeout from the table shown in minutes or seconds and enter in corresponding address location (left digit and right digits).

TIMEOUTS (Alarm Type is selected for Timeout Type in min. or sec.)		
DATA ENTRIES		TIMEOUT
LEFT	RIGHT	
blank (*)	blank (*)	0 min./sec.
blank (*)	1	1 min./sec.
blank (*)	2	2 min./sec.
blank (*)	3	3 min./sec.
blank (*)	4	4 min./sec.
blank (*)	5	5 min./sec.
blank (*)	6	6 min./sec.
blank (*)	7	7 min./sec.
blank (*)	8	8 min./sec.
blank (*)	9	9 min./sec.
blank (*)	0	10 min./sec.

TIMEOUTS (Alarm Type is selected for Timeout Type in min. or sec.)		
DATA ENTRIES		TIMEOUT
LEFT	RIGHT	
blank (*)	B	11 min./sec.
blank (*)	C	12 min./sec.
blank (*)	D	13 min./sec.
blank (*)	E	14 min./sec.
blank (*)	F	15 min./sec.
1	blank (*)	16 min./sec.
1	1	17 min./sec.
1	2	18 min./sec.
1	3	19 min./sec.
1	4	20 min./sec.
1	5	21 min./sec.

TIMEOUTS (Alarm Type is selected for Timeout Type in min. or sec.)		
DATA ENTRIES		TIMEOUT
LEFT	RIGHT	
1	6	11 min./sec.
1	7	12 min./sec.
1	8	13 min./sec.
1	9	14 min./sec.
1	0	15 min./sec.
1	B	16 min./sec.
1	C	17 min./sec.
1	D	18 min./sec.
F	F	2550 min./sec.

For a desired delay/timeout not listed do the following:

- A. Choose a desired delay/timeout, ex: 20 min.
- B. Divide it by 16

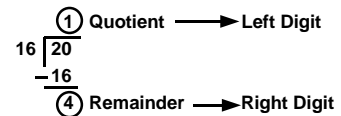

EVENT ID CODES & CONDITIONS ARE ON NEXT PAGE

EVENT ID CODES: Each relay event can be assigned any of the available event IDs from the table.

4. Select 2-digit Event ID from the table shown; enter in corresponding address locations (left and right digit).

EVENT ID CODES		
DATA ENTRIES		OPTION
LEFT	RIGHT	
blank (*)	blank (*)	Area 1 Arm/Disarm
blank (*)	1	Area 2 Arm/Disarm
blank (*)	8	Zone 1
blank (*)	9	Zone 2
blank (*)	0	Zone 3
blank (*)	B	Zone 4
blank (*)	C	Zone 5
blank (*)	D	Zone 6
blank (*)	E	Zone 7
blank (*)	F	Zone 8
1	blank (*)	Zone 9
1	1	Zone 10
1	2	Zone 11
1	3	Zone 12
1	4	Zone 13
1	5	Zone 14
1	6	Zone 15
1	7	Zone 16
1	8	Zone 17
1	9	Zone 18
1	0	Zone 19
1	B	Zone 20
1	C	Zone 21
1	D	Zone 22
1	E	Zone 23
1	F	Zone 24
2	blank (*)	Zone 25
2	1	Zone 26
2	2	Zone 27
2	3	Zone 28
2	4	Zone 29
2	5	Zone 30
2	6	Zone 31
2	7	Zone 32
3	blank (*)	Area 1 Keypad Ambush
3	1	Area 1 Keypad Panic
3	2	Area 1 Keypad Fire
3	3	Area 1 Keypad Medical
3	4	Area 1 Keypad Tamper
3	5	Area 1 Fail to Open
3	6	Area 1 Fail to Close
3	8	Area 2 Keypad Ambush
3	9	Area 2 Keypad Panic
3	0	Area 2 Keypad Fire
3	B	Area 2 Keypad Medical
3	C	Area 2 Keypad Tamper
3	D	Area 2 Fail to Open

EVENT ID CODES		
DATA ENTRIES		OPTION
LEFT	RIGHT	
3	E	Area 2 Fail to Close
4	blank (*)	Test Timer
4	2	Bus Fail
4	3	Guarded RAM Fail
4	4	Low Battery
4	5	AC Fail
4	6	EZM Tamper
4	D	RFEZM Trouble (Fail Tamper)
4	E	RXTx Tamper
4	F	RXTx Trouble (LB/Supervisory)
D	blank (*)	Keypad Fail
D	1	EZM Fail
D	2	Quickloader Device Control
D	4	Quickloader System Reset
D	5	General System Reset
D	8	Area 1 General System Alarm
D	9	Area 2 General System Alarm
F	blank (*)	Relay Group 1
F	1	Relay Group 2
F	8	Area 1 Entry Delay
F	9	Area 2 Entry Delay

RELAY EVENT CONDITION OPTIONS: Each relay event can be assigned an alarm type; and an activation condition; also, select a timeout type for each.

5A. Select Alarm Type and Timeout Type from the table shown; enter in corresponding address location (left digit). **NOTE:** Select timeout from previous page.

5B. Select Activation from the table shown; enter in corresponding address location (right digit).

RELAY EVENT ALARM TYPE OPTIONS		
LEFT DATA ENTRIES	ALARM TYPE	TIMEOUT TYPE
blank (*)	Burglary	Minutes
1	Fire	Minutes
4	Day Zone	Minutes
8	Burglary	Seconds
9	Fire	Seconds
C	Day Zone	Seconds

RELAY EVENT ACTIVATION CONDITIONS	
RIGHT DATA ENTRIES	OPTIONS
1	Alarm
2	Restore
3	Trouble
4	Trouble Restore
5	Follow Zone

SYSTEM RESET OPTIONS (ADDRESS 1197 & 1198)

1197 XX

GEM-RP1CAe2 Keypad

Clear Dealer Program (Erases Dealer Program)

WARNING

This *erases the dealer program*. Use this feature to start a customized default program. Program Data and System Status Memory is erased where Scheduled Data and Zone Descriptions are maintained.

1197XX

GEM-RP2ASe2 Keypad

Access address 1197, then press the  button. Data entry is not allowed.

NOTE: Enter Easy Menu Driven Program Mode to program system again.

1198 XX

GEM-RP1CAe2 Keypad

Cold Start (Erases Entire Program)

WARNING

This erases the entire program including Dealer Program by erasing Program Data, Zone Description Data and System Status Data (similar to a new panel).

1198XX

GEM-RP2ASe2 Keypad

Access address 1198, then press the  button. Data entry is not allowed.

NOTE: Some features (schedules) can only be programmed again with the Downloading Software.

USER PROGRAM MODE

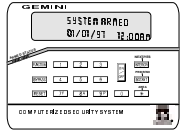

PRELIMINARY INFORMATION

The User Program Mode is covered in detail in the operating instructions for the keypad in use.

- ☞ Only Keypad #1 may be used for programming, however this keypad may be located in any area.
- ☞ The Program Mode cannot be accessed while the communicator is transmitting except during the first three minutes after power-up.
- ☞ After entering codes or data, press the save button. Data will not be stored into memory unless this button is pressed.
- ☞ If the keypad is in the Program Mode and no activity is detected for longer than 4 minutes, a steady tone will sound. Press the button to silence the sounder and exit the User Program Mode.

NOTE: For ease of programming, it is recommended that a GEM-RP1CAe2 be used as Keypad #1. (A new GEM-RP1CAe2 is automatically configured as Keypad #1.)

If a GEM-RP2ASe2 is used, configure address jumpers as Keypad #1 (see the section of this manual Configuring the GEM-RP2ASe2 Keypad). Use the button to manually scroll the display at the end of each programming line.

ACCESSING USER PROGRAM MODE

1. Press
 - ← New Panel (Default User Code = 123)
 - Existing Panel (Any Code with User Program Option Enabled)
2. Press Until "ACTIVATE PROGRAM Y/N" (GEM-RP1CAe2) or "TURN ON PROG Y/N" (GEM-RP2ASe2) appears on LCD screen.
3. Press To Enter User Program Mode
4. Press To Exit User Program Mode when finished

USER CODES

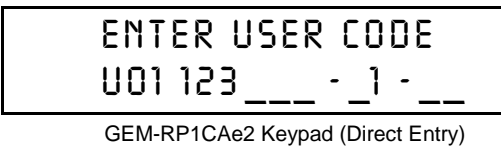

Up to 32 User Codes may be programmed.

NOTE: In this mode, only the code is programmable; the accompanying Area Options must be programmed in the Dealer Program Mode (see page 8).

- ☞ Use the button to place the cursor over the User Number.
- ☞ Enter a User Number (01–32) using the number buttons. The cursor will then advance to the User Code and read the existing code, if any.

User Code NOT USED

GEMINI

U01 123 - - -









Enter user code

To Program User Codes

1. Set Cursor Position using the button.
2. Enter 2-digit User Number (01-32) directly using number buttons (0-9).
3. Enter Code (1-6 digits) directly using number buttons (0-9).
4. Press the button to save each code.

NOTE: Press button to clear character at cursor.
To continue press or .

Programming User Codes

-  Enter the new User Code using the number buttons (0-9). If an old code is displayed, program over it. To erase the digit at the cursor, press   button.
-  Press the  button to save the code in memory.
-  Repeat this procedure for each user. To proceed to Zone-Description programming, press the NEXT () button or the PRIOR () button.







GEM-RP2ASe2 Keypad



(Direct Entry)

To Program User Codes





1. Enter 2-digit User Number (01-32) directly using number buttons (0-9).
2. Press the **FUNCTION** button.
3. Enter Code (1-6 digits) directly using number buttons (0-9).
4. Press the  button to save each code.



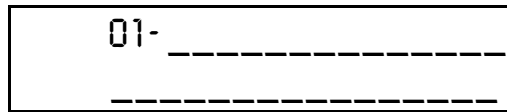





NOTE: Press   button to clear character at cursor. To continue press  or  button.

Programming User Codes





ZONE DESCRIPTIONS (GEM-RP1CAE2 KEYPADS ONLY)







Enter an identifying description for each zone. Buttons  and  set the cursor position; buttons  and  scroll numbers, letters, punctuation marks, etc.



-  Position the cursor over the displayed Zone Number (i.e., "01") using buttons  and .
-  Change the Zone Number using buttons  and .
-  Position the cursor over the first character of the description field. Advancing the cursor between characters, program a description of up to two lines for the new zone using buttons  and .

To Program Zone Descriptions

1. Set the Cursor Position using buttons  and .
2. Select characters for zone description using buttons  and .
4. Press the  button to save each descriptor.

NOTE: Press   button to clear character at cursor. To continue press  or  button.

Programming Zone Descriptions

-  Press the  button to save. Advance to the next zone as in Steps 1 and 2 above and repeat this procedure until all zones have been programmed.

USER PROGRAM MODE

KEYPAD CONFIGURATION MODE

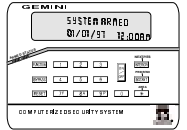

This section will focus on configuring the GEM-RP1CAe2 and GEM-RP2ASe2 Keypads. If there is more than one keypad in the system, *only Keypad No. 1 may be used for programming.*

KEYPAD INSTALLATION

Two types of keypads may be used with the GEM-P1632: the GEM-RP1CAe2 and the GEM-RP2ASe2. Each must be assigned an address number (1–7) and each requires its own configuration procedure (see CONFIGURING THE KEYPADS, which follows, and DIRECT ADDRESS KEYPAD AREA OPTIONS). At least 1 keypad must be used; only 1 is required for a single-area Commercial Burglary installation.

GEM-RP1CAe2 - is a 2-line combination fire/burglary/access keypad capable of supporting 4 EZM zones and a PGM output. A GEM-RP1CAe2 is recommended for use as Keypad #1.

GEM-RP2ASe2 - is a utility LCD keypad combining several preset LCD words with a limited message line. **NOTE:** Due to space constraints, available messages are abbreviated and will scroll automatically.

CONFIGURING THE KEYPADS

A total of up to 7 keypads may be connected to the panel. GEM-RP1CAe2 and GEM-RP2ASe2 keypads may be intermixed but require different configuration procedures, as described in the following paragraphs.

Configuring the GEM-RP1CAe2 Keypad

Each GEM-RP1CAe2 keypad must be configured for (a) keypad tactile beep; (b) entry sounder; (c) keypad address; (d) compatibility number; (e) EZM address; and (f) zone response.

To enter the GEM-RP1CAe2 Configuration Mode:

1. Move jumper JP1 (located at the upper-right corner of the control panel board) from Pins 1-2 (top two) to Pins 2-3 (bottom two). **NOTE:** See Wiring Diagram on page 72.
2. After about 15 seconds, the display will read "XX OUT OF SYSTEM", where XX indicates the keypad address.
3. Press and proceed as follows. (Repeat the following procedure for all keypads.)

**NORMAL
KEYPAD
CONFIGURE**

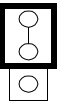

KEYPAD BEEP ON

Keypad Tactile Beep

Upon entering the Keypad Configuration Mode, "KEYPAD BEEP ON" will be displayed, indicating that the tactile beep, which sounds when any button is pressed, is on. To turn off the tactile beep, press the button (the button will toggle the tactile beep on and off). Press the button to continue or press the button to exit.

Entry Sounder

ENTRY SOUNDER ON

To turn off the keypad sounder during entry time, press the button (the button will toggle the tactile beep on and off). Press the button to continue or press the button to exit.

Keypad Address

KEYPAD ADDRESS 01

If more than one keypad is installed, each must be assigned a unique keypad address (that is, no two keypads may be numbered alike):

- ☞ keypads must be numbered consecutively (missing numbers are not permitted)
- ☞ only Keypad No. 1 may be used for programming.



To assign the keypad number, proceed as follows:

1. Enter the assigned keypad number 01–07, then press the button to save. A valid number will be acknowledged by a short beep; an invalid number will be rejected by a long beep.
2. Press the button to continue or press the button to exit.

NEW COMPAT# 0000

Compatibility Number (Not Applicable)



THIS FEATURE IS NOT COMPATIBLE WITH THE GEM-P1632 CONTROL PANEL.

Press the  button to continue or press the  button to exit.

EZM ADDRESS 01

EZM Address

The keypad's internal EZM (Expansion Zone Module) may be utilized to provide four additional wired zones. Whether used alone or in conjunction with optional GEM-EZM series modules or other keypad EZMs, it must be assigned a unique address (or Group number, see Keypad Programming Workbook) similar to its keypad address. If no other EZMs are to be used,

designate the keypad as Group "01" at the "EZM ADDRESS 00" display. In multiple-EZM systems, enter an assigned group number "01" through "06". (Each EZM must have a unique assigned group number, starting with "01" and proceeding consecutively.) Press the  button to continue or press the  button to exit.

Zone Response

The normal loop response of each keypad expansion zone is 750mS, however the response time of any zone can be reduced to 50mS as follows.

ZONE RESPONSE 00

1. Of the following, circle the number(s) in parentheses associated with the zone(s) to be changed:

Zone 1=(1); Zone 2=(2); Zone 3=(4); Zone 4=(8)

2. Add up the circled numbers.



3. At the keypad, enter the sum as a two-digit number "01" through "15" on the display, then press the  button.

Example. Change Zones 2, 3 and 4 to 50mS response.

1. Circle numbers for Zones 2, 3 and 4: (2), (4) and (8).

2. Add up the circled numbers: 2 + 4 + 8 = 14.



3. Enter "14" at the keypad, then press the  button.

Press the  button to continue or press the  button to exit.

PROG CTRL MSG# 1

Program Control Message (Not Applicable)

THIS FEATURE IS NOT COMPATIBLE WITH THE GEM-P1632 CONTROL PANEL.

Press the  button to continue (the display will loop back through selections, for changes) or press the  button to exit the Keypad Configuration Mode (display will read "01 OUT OF SYSTEM"). Then replace Jumper JP5 across Pins 1–2 (top two).

Configuring the GEM-RP2ASe2 Keypad

Up to 7 GEM-RP2ASe2 keypads may be connected to the panel (Keypads 1–7). Each must be configured for a keypad address. In addition, the keypad may be configured to disable (a) touch pad back light; (b) LCD back light; and (c) entry sounder. Keypads are configured by the proper selection of jumpers. Refer to the label on the circuit board fishpaper (LA1390) for jumper locations and a summary of settings.

KEYPAD NUMBER	KEYPAD NUMBER			PARK
	1	2	3	
1	OFF or ON*	OFF	OFF	STORE SPARE JUMPER AT THIS POSITION
2	OFF	ON	OFF	
3	ON	ON	OFF	
4	OFF	OFF	OFF	
5	ON	OFF	ON	
6	OFF	ON	ON	
7	ON	ON	ON	

KEYPAD ADDRESS

If more than one keypad is installed:

☞ Each must be assigned a unique address (that is, no two keypads may be numbered alike).

☞ Keypads must be addressed consecutively (that is, missing numbers are not permitted).

☞ Only Keypad No. 1 may be used for programming. (However, for ease of programming, it is recommended that a GEM-RP1CAe2 be selected as Keypad #1.)

Assign the keypad address number by selecting Jumpers J1–3 in accordance with the table at left.

***Note:** (1) Keypads are factory supplied with no jumpers installed and as such are automatically configured as Keypad No. 1. (2) Only one keypad in the system may be configured as Keypad No. 1, otherwise none will function.

tion.

TOUCH PAD BACK LIGHT

Cut Jumper A to disable touch pad backlighting to conserve 11mA standby current.

LCD BACK LIGHT

Cut Jumper B to disable LCD backlighting.

KEYPAD SOUNDER

Cut Jumper C to disable the sounder. (Do not disable in UL applications.)

KEYPAD CONFIGURATION MODE



NAPCO Security Systems, Inc.
 333 Bayview Avenue, Amityville, New York 11701
 For Sales and Repairs, call toll free: (800) 645-9445
 For direct line to Technical Service, call toll free: (800) 645-9440
 Internet: <http://www.napcosecurity.com>

EASY MENU PROGRAMMING WORKSHEET - 1 OF 3

Name:	Address:
Account Number:	Installer:

Area 1: # of Zones (1-32) = **Zone Doubling?:** Yes No **Area 1: # of Keypads (1-8) =**

NOTE: Area 2 Zones and Keypads are selected in Direct Address Mode. See Zone Options and Keypad Options.

Enter Fire Zones (1-32): _____ **2-Wire Fire Zones?:** Zone 7 Yes No Zone 8 Yes No

Enter Entry/Exit Zones (1-32): _____ **Enter Interior Zones (1-32):** _____

Report all Zones to Central?: Yes No

Central Station Receiver 1 Telephone Number:

Central Station Receiver 1 Account Number:

Central Station Receiver 1 Format:

- | | |
|--|---|
| <input type="checkbox"/> blank (*) = Ademco Slow, Silent Knight Slow
<input type="checkbox"/> 2 = Radionics Fast
<input type="checkbox"/> 3 = Silent Knight Fast
<input type="checkbox"/> 4 = Radionics, DCI, Franklin Slow | <input type="checkbox"/> 5 = Universal High Speed
<input type="checkbox"/> B = SIA
<input type="checkbox"/> C = Ademco Point ID
<input type="checkbox"/> E = Pager |
|--|---|

User Codes:

USER #	CODE (up to 6 digits)	AREA 1 OPTIONS	AREA 2 OPTIONS
1			
2			
3			
4			
5			
6			
7			
8			
9			
10			
11			
12			
13			
14			
15			
16			

USER #	CODE (up to 6 digits)	AREA 1 OPTIONS	AREA 2 OPTIONS
17			
18			
19			
20			
21			
22			
23			
24			
25			
26			
27			
28			
29			
30			
31			
32			

EASY MENU PROGRAMMING WORKSHEETS

EASY MENU PROGRAMMING WORKSHEET - 2 OF 3

EASY MENU PROGRAMMING WORKSHEETS

RF Transmitter Points:

XMTR #	ZONE #	RF ID (printed on xmtr box)					CHECK SUM	# OF POINTS
1								
2								
3								
4								
5								
6								
7								
8								
9								
10								
11								
12								
13								
14								
15								
16								

XMTR #	ZONE #	RF ID (printed on xmtr box)					CHECK SUM	# OF POINTS
17								
18								
19								
20								
21								
22								
23								
24								
25								
26								
27								
28								
29								
30								
31								
32								

Key Fob Transmitters:

KEY FOB #	AREA	RF ID (printed on xmtr box)					CHECK SUM	OPTION 1	OPTION 2
1									
2									
3									
4									
5									
6									
7									
8									

EASY MENU PROGRAMMING WORKSHEET - 3 OF 3

Zone Descriptions (GEM-RP1CAe2 Keypads Only):

ZN #	CHARACTERS AVAILABLE (See below)																												
	1	2	3	4	5	6	7	8	9	10	11	12	13	14	15	16	17	18	19	20	21	22	23	24	25	26	27	28	29
1																													
2																													
3																													
4																													
5																													
6																													
7																													
8																													
9																													
10																													
11																													
12																													
13																													
14																													
15																													
16																													
17																													
18																													
19																													
20																													
21																													
22																													
23																													
24																													
25																													
26																													
27																													
28																													
29																													
30																													
31																													
32																													

Characters Available for Zone Descriptions
 ! @ # \$ % ^ & * () _ + ! ! ! { } [] ` , . < > ?
 1 2 3 4 5 6 7 8 9 0
 a b c d e f g h i j k l m n o p q r s t u v w x y z
 A B C D E F G H I J K L M N O P Q R S T U V W X Y Z

Dealer Code:

EASY MENU PROGRAMMING WORKSHEETS

PROGRAMMING OPTIONS INDEX

PROGRAMMING OPTION	PROGRAM MODE	ADDRESS LOCATION	PAGE NUMBER
3/1 with Extended Restores	Direct Address	0171, 0193 & 0215	26
Abort Delay	Direct Address	0715	12
AC Fail Report Delay	Direct Address	0717	12
Access Control on PGM2 Output	Direct Address	0719	22
Alarm Output Timeout	Direct Address	0712	23
Auto Bell Test on Arming	Direct Address	0719	25
Auto Reset after Burglary Output Timeout	Direct Address	0719	25
Automatic Interior Bypass	Direct Address	0722	25
Backup Reporting on Telco 2	Direct Address	0429	28
Callback Telephone Number	Direct Address	0236-0255	23
Cancel Next Test timer on any Report	Direct Address	0394	28
Change Pulse Output to Cadence	Direct Address	0719	25
Chime Timeout	Direct Address	0716	22
Clear Dealer Program	Direct Address	1197	37
Closing Report only on Conditional Close	Direct Address	0718	25
Cold Start	Direct Address	1198	37
CS Receiver 1, 2 & 3 Telephone Numbers	Direct Address	0172-0191, 0194-0213 & 0216-0235	26
CS Receiver 1, 2 & 3 Formats	Direct Address	0170, 0192 & 0214	26
CS Telco 1, 2 & 3 Subscriber Event ID Numbers (System)	Direct Address	0275-0278, 0295-0298 & 0315-0318	27
CS Telco 1, 2 & 3 Subscriber Event ID Numbers (Area 1)	Direct Address	0227-0270, 0287-0290 & 0307-0310	27
CS Telco 1, 2 & 3 Subscriber Event ID Numbers (Area 2)	Direct Address	0271-0274, 0291-0294 & 0311-0314	27
CS Telco 1, 2 & 3 Subscriber Opening/Closing ID Numbers (Area 1)	Direct Address	0259-0262, 0279-0282 & 0299-0302	27
CS Telco 1, 2 & 3 Subscriber Opening/Closing ID Numbers (Area 2)	Direct Address	0263-0266, 0291-0294 & 0303-0306	27
Dealer Code	Easy Menu Driven	N/A	10
Disable Callback Download	Direct Address	0720	25
Disable Closing Reports	Direct Address	0392	28
Disable Function Mode Download	Direct Address	0720	25
Disable Opening Reports	Direct Address	0391	28
Disable Wait for Handshake	Direct Address	0394	28
Disable Wait for Silence	Direct Address	0394	28
Enable Manager's Mode	Direct Address	0719	25
Enable Global Ambush Code	Direct Address	0720	25
Enable Auto Arm if not closed	Direct Address	0718	25
Enable Line Fault Test	Direct Address	0721	25
Enable Residential Fire	Direct Address	0720	25
Enable Transmitter Telco 1	Direct Address	0721	25
Enable Transmitter Telco 3	Direct Address	0721	25
Enable Zone Doubling	Direct Address	0721	25
Enable Zone Number on Pulse Alarm	Direct Address	0171, 0193 & 0215	26
Entry Delay 1	Direct Address	0001	22
Entry Delay 2	Direct Address	0002	22
Exit Delay	Direct Address	0000	22
Enable EZM Group	Direct Address	0737-0742	30
Global Ambush Code	Direct Address	1054	24
Include Select/Group Bypass in Conditional Close/Status	Direct Address	0718	25
Interior 1 Normally Bypassed	Direct Address	0720	25
Key fob Transmitters	Easy Menu Driven	N/A	10
Leading Digits for Pager Format	Direct Address	0256 & 0257	23
Number of Rings before Pickup	Direct Address	1183	23
Opening Report only after Alarm Report	Direct Address	0718	25
PGM1 Output Timeout	Direct Address	0714	23
PGM2 Output Timeout	Direct Address	0710	23
PGM2 Output Access Control Timeout	Direct Address	0711	22
PGM2 Output Chirp on Key fob Arming	Direct Address	0722	25
PGM2, Don't Clear Output with Arm/Disarm	Direct Address	0722	25
Pulsed Alarm Output Timeout	Direct Address	0713	23

PROGRAMMING OPTION	PROGRAM MODE	ADDRESS LOCATION	PAGE NUMBER
Reset Day zone with Arm/Disarm only	Direct Address	0720	25
RF Transmitter Points	Easy Menu Driven	N/A	9
Status Report	Direct Address	0718	25
Sum check	Direct Address	0171, 0193 & 0215	26
Suppress Bypass Reminder when Armed	Direct Address	0719	25
Touch-tone Dialing Only	Direct Address	0394	28
Touch-tone Dialing w/Rotary Backup	Direct Address	0394	28
Two Ring Download	Direct Address	0722	25
User Codes	Easy Menu Driven	N/A	8
User Opening/Closing Telco 1 & 3 (Users 00-32 & 97-99)	Direct Address	0430-0449	29
Veriphone Zones over Priority Alarms	Direct Address	0722	25
Veriphone Zones trip PGM2 Output	Direct Address	0722	25
Zone Descriptors	Easy Menu Driven	N/A	10
Zones Report Code (Zones 1-32)	Direct Address	0358-0389	28



GLOSSARY

Abort Delay (Do not program for UL Applications.)

A reporting delay period that allows cancellation of the central-station report by disarming the control panel. To enable program zones for *Abort Delay* (Address 0510, 0565, 0620 & 0675) and select *Abort Time Delay* (Address 0715). Also, a *Pre-Alarm Warning* may be selected for zones (Address 0497, 0552, 0607 & 0662) allowing a keypad indication of alarm with no alarm outputs or central station reporting for the duration of abort delay time.

NOTE: If Abort Delay is selected for a 24-Hour Zone, the zone must be cleared before disarming the area.

AC Failure; AC-Fail Report Delay

If AC power is removed from the control panel, "E01-00 AC POWER FAIL" will display at the keypad with a flashing "SYS/TRBL" as a reminder and a pulsing sounder. Press the **[RESET]** button to silence the sounder; the "SYS/TRBL" reminder will remain on and "SYSTEM READY" will appear in the display. If a User Code is entered within 5 minutes, the panel may be armed successfully. After 5 minutes, the system trouble will again display.

AC Failure may be programmed to activate the *Alarm Output* (Address 0450), *Pulsed Alarm Output* (Address 0451), *PGM1 Output* (Address 0452), *PGM2 Output* (Address 0453), *Relay Outputs* (Address 0750-0829) and/or report to a central station by selecting *AC Fail Report Event Telco 1*, *AC Fail Report Restore Telco 1*, *AC Fail Report Event Telco 3*, *AC Fail Report Restore Telco 3* (Address 0454, 0455, 0458 and 0459, respectively). An alarm and/or restore report to the central station will occur immediately unless an AC Fail Report Delay is programmed (Address 0717). AC Failure is logged immediately upon detection.

Access Control; Access Control (Panel Access) on PGM2 Output; PGM2 Output Access Control Time; Keypad Access; Access Only; Access Logging

NOTE: The GEM-P1632 has not been evaluated by UL for compliance with UL294 (Access Control Systems).

If Access Control on PGM2 Output (Address 0719) is selected, entering the Access Code (see User Code Programming in Easy Menu Driven Mode Programming) while disarmed will trip the panel's PGM2 Output. This is commonly used to activate a door strike for the purposes of remotely unlocking a door. Each keypad is individually selected for Panel Access (Address 0730-0736). Also program PGM2 Output Access Control Timeout (Address 0711). **NOTE:** Do not program the PGM2 Output (Address 0454, 0474, 0482, 0503, 0558, 0613 and 0668) as an output on alarm.

Keypad Access is selectable for any keypad 1-7 by selecting the appropriate Area Option of any User Code (see User Code Programming in Easy Menu Driven Mode Programming); select the Panel Access option (Address 0730-0736) for those keypad numbers (1-7) that are to respond to the User Code. However, if the Access Byte is programmed, the code will no longer function as an Arm/Disarm Code. Also, if Access Only is programmed for any keypad, that keypad will be dedicated for keypad access. It will then display "ENTER CODE" and will no longer be capable of arming or disarming.

Entering a valid code at the keypad will cause a 5-second output on the keypad's PGM line with a pulsing sounder and the display "**ENTER NOW**" (or other customized message). If Access Logging is programmed, keypad access control will be added to the event log, by keypad. An RB1000 Relay may be used to activate a door strike. Power to the door strike should be supplied from an independent source.

Access Number for Outside Line (CS Receiver Telephone Number Access)

Some subscribers will have a telephone system that requires one digit to access an outside line. The first dial tone encountered (prior to the access number) may have a frequency that is different from that of the accessed dial tone (440Hz). One or more 4-second Pre-Dial Delay "D"s may be entered before any of the CS Receiver Telephone Numbers (Address 0172-0191, 0194-0213 & 0216-0235) instead of a dial tone with frequency "E". See Pre-Dial Delay; Telephone Numbers. (Note: The panel features automatic dial-tone detection and will normally not require any "E"s. To disable this feature, see address 0394.)

If the subscriber's system uses an access number, contact the telephone-equipment supplier to find out if a dial tone other than 440Hz is received prior to dialing the access number. If the communicator must delay before dialing the access number instead of attempting to recognize the dial tone, find out how many 4-second delays must be programmed.

Alarm on Day Zone See Day Zone

Alarm Outputs (See Wiring Diagram for UL requirements.)

The GEM-P1632 has three outputs: Bell (Burg. & Fire), PGM1 and PGM2. The following table summarizes wiring for signaling an alarm in typical installations. See Time Selection for timeout durations.

OUTPUT	WIRING	REMARKS
Bell Output (Burg.)	3(+) & 4(-)	Single Bell Output; program Alarm Output for Burg (Addr. 0450, 0471, 0479, 0500, 0555, 0610, 0665, 0745)
Bell Output (Pulsed)	3(+) & 4(-)	Single Bell Output; program Pulsed Output for Fire (Addr. 0451, 0470, 0478, 0501, 0555, 0611, 0666, 0746)
PGM1 Output	5(+) & 7(-)	Programmable Output (Addr. 0452, 0472, 0480, 0502, 0556, 0612, 0667, 0747)
PGM2 Output	5(+) & 8(-)	Programmable Output (Addr. 0453, 0474, 0482, 0503, 0557, 0613, 0668, 0749)

Alarm Outputs

In UL installations, (1) see Time Selection for timeout requirements; (2) combination residential burglary/fire systems require distinctly different signals for burglary and fire.

NOTE: For dry contacts, use RB1000 Relay Module (see Wiring Diagram).

Alarm; Alarm Restore Telco 1/Telco 3 See Report Telco 1/Telco 3

Alarm; Alarm Restore Telco 2 See Backup Report on Telco 2

Alarm Verification (Not for use in California.)

An alarm on any Fire Zone programmed for "Fire Alarm Verification" will cause all fire zones to be powered down for 12 seconds. (All devices must be wired with + power on Terminal 25.) After this time, power is restored and a 4-second power-up time is started. Thereafter, the zone will be active again. This represents a total processing delay of 16 seconds from the time the alarm is first detected. If an alarm condition still exists at this time or reoccurs within 2 minutes, an alarm will be initiated, otherwise the zone will return to its original state. **NOTE:** A zone programmed for "Fire Alarm Verification" must be programmed as a "Fire Zone" as well.

Ambush (Keypad Ambush)

A 2-digit code that is entered immediately prior to (and as part of) the regular Disarm Code. This will cause a silent report to be sent to a central station. Thus, should a user be forced to disarm, he can silently signal an emergency while appearing to be merely disarming the system. The Ambush Zone will automatically report when programmed to report on alarm.

To program, (a) select "Ambush to Report Event Telco 1/Telco 3" (Address 0475, 0477, 0483, 0485); (b) select "Enable Global Ambush Code" (Address 0720); enter "Global Ambush Code" (Address 1054); and (d) enter an "Ambush CS Report Code" (0340). Each keypad is enabled for "Ambush" individually (Address 0730-0736). Inform the user what the Ambush Code is, and that his Arm/Disarm Code must be entered less than 10 seconds after the Ambush Code for an ambush report to be sent.

Answering Machine Pickup Without Line Seizure See Callback-Method Download.

Anti-Jam Time

If the communicator does not detect a dial tone within 12 seconds, the Anti-Jam feature will be activated. That is, the communicator will go off line for a 16-second anti-jam interval in order to free the telephone circuit from an incoming call, then make another 12-second attempt at dial-tone detection. If still unsuccessful, the communicator will again go off line for 16 seconds, then proceed to dial anyway.

Areas; Zone Area 1–Zone Area 2; Priority Area Arming

Although the default program will automatically set up Zones 1 through 8 for Zone Area 1, the panel may be partitioned into two areas. Every zone must be assigned to at least one area (Address 0526, 0527, 0581, 0582, 0636, 0637, 0691, 0692) to be used. At least one zone must be assigned to Area 1. If a zone is selected for both areas, that common zone will not arm until both areas are armed. If any zone disarms, the common zone will disarm.

In a multiple-area system, be sure to also enable *User Codes by Area*.

Keypad Area Assignments

Bell Control (determines which bells an area may silence);

Subscriber Opening/Closing ID Numbers and Event ID Numbers (if reporting);

System Trouble Subscriber ID Number

If "Priority Area Arming" (Address 0743 & 0744) is selected, the Priority Area must be armed before the Arming Area can be armed.

Auto Bell Test on Arming (Required for UL Mercantile installations)

If selected (Address 0719), this will activate the Burglary Output briefly 10 seconds after the area is armed. If the alarm does not sound, the device may be defective.

Auto-Bypass (Do not program for UL installations.); Auto-Bypass Re-entry

Zones programmed for "Auto-Bypass" (Address 0493, 0548, 0603, 0658) will be bypassed (automatically removed) if in trouble when arming. A momentary beep will sound at the keypad to warn that the system has been armed without the protection of the auto-bypassed zone. (Note that the exit/entry door must be closed before arming, otherwise the Exit/Entry Zone will be auto-bypassed.)

Note: A zone in trouble that is not programmed for "Auto-Bypass" will cause an alarm on arming after a 10-second arming delay.

If "Auto-Bypass Re-entry" (Address 0496, 0551, 0606, 0661) is selected, securing a zone that is programmed for Auto-Bypass, while armed, will cause that zone to re-enter the system in an armed state.

Auto Interior Bypass See Interior Zones by Area



Auto-Reset; Auto-Reset After Burglary Output Timeout

If a zone detects an alarm condition and is selected for "Auto-Reset" (Address 0507, 0562, 0617, 0672), it will automatically rearm itself as soon as the alarm condition is cleared. Auto-Reset may be delayed to occur after the Burglary Output timeout period by selecting "Auto-Reset After Burglary Output Timeout" (Address 0719) and "Auto-Reset". Zones that are not programmed for "Auto-Reset" will not be capable of signaling another alarm until (a) the cause of the alarm has been corrected and (b) the control panel is disarmed. Also see Swinger Shutdown.

Auxiliary Relay See Alarm Outputs

Backup Report on Telco 2

If "Backup Reporting on Telco 2" (Address 0394) is selected and the communicator does not reach the first telephone number after two attempts, seven attempts will be made to reach the second telephone number. Enter Subscriber Identification Numbers for Telephone 2 and other information required for Telephone 2. Also program Backup Report on Telco 2. Any zone programmed to report to Telco 1 will backup report to Telco 2. Note: Subscriber Identification Numbers for both Telephones 1 and 2 must be entered, even if they are the same.

Battery

12Vdc standby power source in the control panel is used to provide backup protection in the event of a power loss. The battery is an integral part of the system and must be installed, even if ac power is present. Change the battery every 5 years or as required.

Bell Control

In any system, the ability to silence any combination of alarm devices (outputs) initiated from any area. Bell Control must be programmed for all systems to be able to silence an alarm. For example, in a two-area system, each area could be programmed to silence only those alarms initiated within its own area; or both areas could be programmed to silence an alarm initiated from either area.

Burglary Output See Alarm Outputs

Bus Failure

Communication failure on the 4-wire bus will cause a system trouble and a report to the central station. Program System Trouble Reports and Report Codes for the 4-Wire Bus.

Call Waiting See Disable Call Waiting

Callback-Method Download; Answering Machine Pickup Without Line Seizure; Disable Callback Download (Required for UL installations); 2nd Call Download (Required for UL installations); Disable Function-Mode Download; Number of Rings Before Pickup

Data may be downloaded remotely to the panel after a programmed number of rings (3 to 15) and a control-panel confirmation call-back. Program the "Number of Rings" (Address 1183); if not programmed, the panel will pick up after 15 rings.

This method will accommodate an answering machine at the site. "2nd Call Download" (Address 0722) must not be programmed.)

The answering machine will pick up on its programmed number of rings, as usual. **Note:** The number of rings programmed into the panel must exceed that of the answering machine.

Program "Disable Callback Download" (Address 0720) to prevent unauthorized downloading to an unattended panel. Program "Disable Answering Machine Download" to inhibit downloading to a telephone connected to an answering machine. Program "Disable Function-Mode Download" (Address 0720) to prevent downloading at the keypad.

Cancel Next Test Timer Report on Any Report See Test Timer

Chime (Displays "MONITOR" on GEM-RP2ASe2 Keypads)

This annunciator feature may be used on any zone to sound a tone at the keypad while disarmed when the zone goes into trouble. Access the ACTIVATE CHIME function (Easy Menu Driven Program Mode) to enable or disable the Chime Mode. This feature is programmable by zone (Address 0509, 0564, 0619, 0674) and "Chime Timeout" (Address 0716). A time must be programmed for the chime to function.

Clear Program

Caution: Erases the dealer program. Use this feature to start a new customized default program. Access Address Location 1197, then press the  button.

Closing Report; Closing Report Only on Conditional Closing; Conditional Closing; Include Selective/Group Bypass In Conditional Closing/Status; Status Report

On arming, the communicator can transmit a unique Closing Code for each user and a status report that identifies the problem zone to the central station. Note that Subscriber Identification Numbers and a Closing Code must be entered for any closing report.

Select which users will report closings for each telephone number, even if "Closing Report Only on Conditional Closing" is selected. Normally, a closing report will consist of the Closing Code and the number of the user that armed. If the user armed with an auto-bypassed zone (or selective/group bypassed zone if "Include Selective/Group Bypass In Conditional Closing/Status" was programmed), the Conditional Closing Code will also be sent.

Select "Closing Report Only on Conditional Closing" to report only when arming with an auto-bypassed zone (and selective-/group-bypassed zone if "Include Selective/Group Bypass in Conditional Closing/Status" is programmed).

Select "Status Report" to send a closing followed by a status report that identifies the problem zone(s). A typical Status Report is represented by the following example.

Example (4/2 Format). A burglar breaks into a commercial establishment during the night, breaking the window foil on Zone 5. The Open/Close Subscriber Identification Number is "1234"; the Alarm Code for Zone 5 is "3,5" (Burglary Zone 5); the Subscriber Identification Number is "6789"; the Closing Code is "C". The communicator will send the following report to the central station.

When alarm occurs:

"6789 35" – Alarm, Zone 5

Closing Report:

"1234 C1" – Closing, User 1 (User 1 returned, inspected damage & rearmed; the same transmission would occur for User 11, 21, 31, etc.)

"1234 F5" – Trouble, Zone 5 (zone status at time of closing: Window foil still broken; Zone 5 auto-bypasses, repair required; the same transmission would occur for Zone 15, 25, 35, etc.)

Cold Start

Caution: Erases the entire program (codes, schedules, etc.), leaving the panel as it came right out of the box. Access Location 1198, then press the  button.

Data Format

Ask the central station which of these formats to use.

Two-Digit or 4/2 Format. Some central-station receivers require that a four-digit Account Code followed by a two-digit Alarm Code be sent in each report. Example. In a certain installation, the Alarm Subscriber Number is "1234"; a burglary alarm occurs on Zone 1. The Alarm Code for Zone 1 is "3". The communicator will send "1234 31" (Account No. 1234; Alarm, Zone 1). 1400Hz Handshake/Kissoff. 1400Hz Handshake overrides 2300Hz Handshake if both are selected. 2300Hz Handshake/Kissoff. Used with the following receiver formats: Radionics, DCI & Franklin Slow; Radionics Fast; Sescoa, Vertex, DCI & Franklin Fast; Radionics BFSK. 1400Hz Handshake overrides 2300Hz Handshake if both are selected.

- ✓ **Zone Number on Pulse Alarm.** If selected, an Alarm Code need not be programmed (the zone number will replace the Alarm Code), however codes for restore, trouble, etc. are still required. Thus, in the foregoing example, if "E" is the designated Restore Code, and Zone 24 trips and is restored, the communicator will send "1234 24" (Account No. 1234; Alarm, Zone 24) followed by "1234 E6" (Account No. 1234; Zone 24 Restored).
- ✓ **Single-Digit Event Code Format.** The single digit sent for a particular event can be either the Event Code or the units digit of the zone number.
- ✓ **Sum-Check Format.** Sum Check is a sophisticated data format used to enhance the speed and check the accuracy of the received transmission. This format should be preferred whenever the central station is capable of receiving it. After transmitting the Subscriber Identification Number and the Alarm Code, the communicator sends a verifying digit that is the sum of both. The receiver compares the verifying digit with the sum of the other numbers to check transmission accuracy.
- ✓ **3/1 with Extended Restores.** Some receivers require a three-digit Account Code followed by a single-digit Alarm Code. Example. In another installation, the Alarm Subscriber Number is "123"; an alarm on Zone 1 is restored. The Restore Code for Zone 1 is "E,1". The communicator will send "123 E" (Account No. 123 Restored); followed by "EEE 1" (Restored, Zone 1).
- ✓ **Modem Formats.** Modem formats (SIA, Point ID, Express, 4/3/1, Modem 2) are preset and automatic but require a Type for each zone. Program Zone Type as follows: Fire* = "1" (Note: Not for Modem 2 Receivers); Panic = "2"; Burglary = "3"; Holdup = "4"; Gas Alarm = "7"; Heat Alarm = "8"; Auxiliary Alarm = "A" (Keypad displays "0"); 24-Hour Aux. Alarm = "B".
- ✓ **Pager Formats.** The control panel has provisions for dialing a pager phone number. The panel will wait for ringing, wait for silence, then send its data. Caution: Because there is no handshake/kissoff, this feature should only be used for Double Reporting; it may not be used for Backup Reporting. Only one report is sent for any call. Pager digits are limited to "0" through "9". Digits represented by "A" through "F" will be converted to "0" for transmission purposes. Pager formats are 10 digits, arranged as illustrated by the following examples.



Alarms, restores, etc. are transmitted in a 3-3-4 arrangement representing Report Code, Descriptor and Account Number.

Example 1. Burglary, Zone 22 (Report Code = "3".)

Transmits: 003 022 1234, where

003 = Report Code (always two zeros + programmable Report-Code digit, 0–9);

022 = Descriptor (always one zero + 2-digit descriptor, zone number: 01–32);

1234 = Account Number (4 digits, programmable).

Openings, closings, etc. are transmitted in a similar arrangement

Example 2. Closing, User 12 (Closing Code = "8")

Transmits 008 012 1234, where

008 = Report Code (always two zeros + programmable Opening/Closing digit, 0–9)

012 = Descriptor (always one zero + 2-digit descriptor (user number: 01–32);

1234 = Account Number (4 digits, programmable).

Keypad Report Codes and System Report Codes are transmitted in the same format.

Compatible Receivers. The following receivers are compatible with the GEM-P1632:

- ✓ **FBI CP220.** Formats: Ademco Slow; Silent Knight Slow; Silent Knight Fast; Sescoa; Vertex; DCI; Franklin Slow; Franklin Fast; SIA; Radionics Slow; Radionics Fast; Radionics BFSK; FBI 4/3/1; Universal High Speed.
- ✓ **Ademco 685.** Formats: Ademco Slow; Silent Knight Slow; Silent Knight Fast; Sescoa; Vertex; DCI; Franklin Slow; Franklin Fast; Radionics Slow; Radionics Fast; Radionics BFSK; Universal High Speed; Ademco Point ID; Ademco Express.
- ✓ **Radionics 6500.** Formats: Ademco Slow; Silent Knight Slow; Silent Knight Fast; Sescoa; Vertex; DCI; Franklin Slow; Franklin Fast; Radionics Slow; Radionics Fast; Radionics BFSK; Universal High Speed.
- ✓ **Osborne-Hoffman Quicalert.** Formats: Ademco Slow; Silent Knight Slow; Silent Knight Fast; Sescoa; Vertex; DCI; Franklin Slow; Franklin Fast; SIA; Radionics Slow; Radionics BFSK; Universal High Speed; Ademco Point ID; Ademco Express.
- ✓ **Silent Knight 9000.** Formats: Ademco Slow; Silent Knight Slow; Silent Knight Fast; Sescoa; Vertex; DCI; Franklin Slow; Franklin Fast; Radionics Slow; Radionics Fast; Radionics BFSK; Universal High Speed; SIA.

Day Zone(Open; Short); Alarm on Day Zone; Disable Auto-Reset on Day Zone; Reset Day Zone with Arm/Disarm Only; Enable Watch, Areas 1-2 (By Area)

A Day Zone will give an audible and visual indication at the keypad if there is a problem on the loop while disarmed. Open- and short-circuit conditions are programmed separately, by zone. This feature may be used to warn of a problem (a break in a window foil, for example) during the day, when the panel is not normally armed. When the Day Zone is tripped, "DAY ZONE TRBL" and the zone number(s) will alternately display at the keypad and the sounder will pulse. Press the pressing the **RESET** button to silence the sounder and reset the keypad. "ZONE FRULT" will be displayed until the condition is corrected. If Reset Day Zone With Arm/Disarm Only is programmed, arm and disarm the panel to reset the Day-Zone indication at the keypad.

If Alarm on Day Zone is programmed for a zone, a Day Zone condition will cause the alarm outputs programmed for that zone (sirens, relays) to activate.

Note: (1) If a zone is programmed for both "Day Zone Open" and "Day Zone Short", either condition must be reset before the other can activate. (2) Day Zone Short will not function if No EOL Resistor is also programmed.

Report Trouble or Trouble Restore is programmed in conjunction with Day Zone Open/Day Zone Short and Trouble on Open/Trouble on Short (the trouble reported will be that programmed under Day Zone Open and/or Day Zone Short).

Note: Do not program a Day Zone for 24-hour protection. The keypad will announce as a Day Zone but the panel will transmit an Alarm Code and a Trouble Code when tripped.

Program Disable Auto-Reset on Day Zone to prevent repeated Day-Zone trips. This will cause the keypad display and sounder to activate only once in any arm/disarm period.

If Enable Watch is selected (by area), zones programmed for Day Zone can only be activated when ACTIVATE WATCH is accessed. (See Section 3.) Arming and disarming will turn off the Watch Mode. If "Report Trouble" is selected, a trouble on a Day Zone will be reported only when the Watch Mode is on.

Dealer Security Code

The factory-programmed Dealer Security Code is "456789". Use this code to enter the Easy Menu Driven Mode (Dealer Program Mode) to program (or change) the Dealer Security Code. The Dealer Security Code is needed to enter the Dealer Program Mode, thus allowing the dealer to program codes, zone features, reporting features and zone descriptions. This code may be changed as required.

Dial-Tone Detection; Disable Auto Dial-Tone Detection

The panel features automatic dial-tone detection to ensure that a dial tone is present before the communicator dials. To disable this feature, program an "8" in Location 0429.

When an "E" is programmed before the first digit of an outside telephone number, the communicator dial-tone detection circuit is set to detect the standard 440Hz dial tone. The "E" is generally entered in the location immediately preceding the telephone number.

It may be necessary to program at least one 4-second pre-dial delay before a dial-tone detection "E". With certain nonstandard exchanges, pre-dial delay "D"s may be used without a dial-tone detection "E". (See Access Number for Outside Line; Pre-Dial Delay; Telephone Numbers.)

Disable Answering Machine Download See Callback-Method Download

Disable Auto-Reset on Day Zone See Day Zone

Disable Auto Status

Non 24-Hour Zones that are open (or shorted) normally display "ZONE FRULTS" (while disarmed) followed by the zone number(s) and description(s). In high-security applications, program Disable Auto Status. Unsecured zones will then be indicated by a "CHECK STATUS" display. Status may be displayed manually using the DISPLAY STATUS function, however a valid user code will be required.

Disable Auto-Unbypass on Disarming

Normally, manually bypassed zones revert to active (disarmed) zones on disarming. Select this feature to maintain bypassed zones on disarming until manually unbypassed.

Disable Call Waiting (touch-tone® Dialing Only)

A digital communicator connected to a telephone line with Call Waiting may be disrupted by this feature. However, most lines with Call Waiting also have Selective Call Waiting, which permits the feature to be turned off by dialing a "*70" just before the telephone number. A "*" will be dialed by programming a "B".



If the installation has the Call Waiting feature, be sure that it also has Selective Call Waiting, and confirm the disable code with the telephone company. Then program this code ("B70") directly before the phone numbers (after dial-tone detection or pre-dial delay) in the telephone-number locations. See Telephone Numbers.

Caution: Should the user cancel his Call Waiting service, the communicator will dial a wrong number unless the phone number is corrected.

Disable Callback Download See Callback-Method Download

Disable Code Required for Easy Bypass See Selective Bypass (Do not program in UL Installations)

Disable Fire Reset (by Area)

Normally, pressing the  button will momentarily remove power to the smoke detectors. If "Disable Fire Reset" is selected for any area, the  button will no longer activate the Reset Output so that the integrity of the smoke detector's Alarm Memory feature (LED indication) will be maintained. Also see Alarm Outputs; Smoke Detectors.

Disable Function-Mode Download See Callback-Method Download

Disable Openings/Closings

Provides the flexibility of disabling openings and/or closings from any area(s).

Disable Wait-for-Handshake/Kissoff

Causes data transmission to start immediately after the telephone number.

Disable Wait-for-Silence (Pager Format)

Causes data transmission to start immediately after the pager telephone number.

Double Reporting See Report Telco 3

"E" Lugs (E5, E15, E19)

E5 - Lug E5 is used for Line Seizure. It is normally at 12V and when the telephone line is seized it goes to approximately 1V DC.

E15 - Lug E15 is used for Armed State. It is normally at 12V and when the system is armed it goes to approximately 1V DC.

E19 - Lug E19 is the Listen in Lug. It is an input and when it is forced low the panel will silence the keypad sounder and bell outputs so that the Veri-phone can listen to activity at the residence. See Veri-Phone (WI783): Silence All Outputs During Audio Session. Use Napco Part No. WL1 for field wiring.

Easy Arming

Permits quick arming by simply pressing the  button. Each keypad may be individually programmed for Easy Arming (see Keypad Features). Disarming still requires entry of a valid user code. Do not program Easy Arming in UL installations. If closings are reported, Easy Arming will report as User 99.

Enable Burg Output Warning On Entry

Causes the Burglary Output to “chirp” if the entry door is opened within 60 seconds after exit time has elapsed. This feature may be useful in cases where a keypad is not within audible range to remind a user to disarm if inadvertently exiting after exit delay has expired.

Enable Exit Delay Restart See Entry/Exit Delay

Enable Line Fault Test

Enable Line Fault Test will cause the panel to monitor the phone line. A failure will display as “E08-00 TELCO LINE1 FAIL”. Program this system trouble to activate the Burglary Output.

Enable Local Alarm on First Zone “AND” Trip See Zone ANDing (Do not program in UL installations.)

Enable User Code by Area See User Codes/Authority Levels/Access Bytes

Entry/Exit Delay; Entry/Exit 1; Entry/Exit 2; Entry Relay; Enable Exit-Delay Restart

Delays permit exit and entry through the Entry/Exit Zone(s) after the system is armed without setting off an immediate alarm. Entry delay allows the user time to enter and disarm the panel. Exit delay allows the user to leave the premises after the panel has been armed. Unless the keypad has been configured otherwise, the sounder will come on and will pulse during the last 10 seconds of entry delay to remind the user to disarm.

Two individually-programmable entry-delay times are provided to accommodate different entry zones. If two or more Exit/Entry Zones are entered in succession, the delay programmed for the last Exit/Entry Zone entered will take precedence over all others. Exit-Delay time and Entry-Delay time may each be programmed for up to 255 seconds (4 minutes). See Time Selection.

An external relay may be programmed to trip upon entry (see Programming Manual: Relay Event ID Codes, Area Entry Relays), and remain on for a programmed duration.

If the system has been armed with “Exit-Delay Restart” enabled, when the exit door is opened and then closed, the programmed exit delay will restart at 60 seconds. Thus, if a long exit delay is programmed, it will be reduced to 60 seconds after exiting, yet still allow reentry before entry time starts. If re-entry occurs within that 60 seconds, exit delay will restart once again (and only once again) at 60 seconds.

If re-entry occurs within 60 seconds after exit delay has expired, the alarm will sound a 2-second warning (with the entry sounder) to remind the user to disarm. (Exit-Delay Restart may be useful in reducing false alarms caused by a user who re-enters the premises shortly after exiting.)

Note: In UL installations, maximum exit delay is 60 seconds; maximum entry delay is 45 seconds. In UL Mercantile installations, maximum entry delay is 60 seconds.

Entry delay may be cancelled by pressing the **INSTANT** button prior to arming, however it will be restored automatically upon disarming. (When armed with Instant protection, an “I” will appear at the right side of the display.)

Exit/Entry Follower

A zone programmed as an Exit/Entry Follower will ignore detection during the exit delay, and only during entry delay if the Exit/Entry Zone is entered first. Thus, detection devices (passive infrared detectors, for example) along the path between the keypad and the exit/entry door will not signal an alarm during exit/entry delay under normal conditions. However, if a device in the Exit/Entry Follower Zone detects a violation when the exit/entry door has not first been entered, there will be no entry delay and the Exit/Entry Follower Zone will go into an instant alarm. If the panel is armed with the entry delays cancelled (Instant protection), any violation on the Exit/Entry Zone or the Exit/Entry Follower Zone will cause an immediate alarm.

Expansion Zones; EZM Type; EZM Tamper See Tamper

Zones 9–32 or 17-32 (with “Zone Doubling” enabled) are expansion zones added to the basic system using expansion zone modules (EZMs). Any combination of GEM-EZM4 (4 zones), GEM-EZM8 (8 zones) and/or the 4-zone modules integral to each GEM-RP1CAe2 keypad may be used. Refer to the instructions accompanying each module for wiring information.

Regardless of how the modules are arranged, the expansion zones are divided into consecutively-numbered groups of four. Each 4-zone module comprises one group of zones; each 8-zone module comprises two groups. Each group is assigned a number.

EZ Zone Doubling

The control panel zone configuration may be expanded from 8 to 16 zones without the use of EZM Modules. To do so simply select “Zone Doubling” (Address 0721) and connect zones as shown in Wiring Diagram. The 3.9K EOL resistor must be placed across the terminals of the higher zone. For proper supervision, the 2.2K EOL resistor must be placed at the end of the loop of the lower zone.

NOTE: If Zone Doubling is to be used, then normally closed devices must be wired to both zones. If Normally open zones for fire or panic devices are required, then the lower zone (2.2K EOL resistor) must be used and the higher zone (3.9K EOL resistor) must not be programmed for any area.



Fire; Keypad Fire

Any zone may be programmed for Fire. Connect normally-open devices across a Fire Zone. (The EOL2.2K end-of-line resistor must be installed.) A short across the zone will cause a fire alarm, which will be indicated at the keypad by a "FIRE" LCD display and pulsing sounder. An open circuit on the Fire Zone will identify a trouble and cause flashing "FIRE" LCD display and pulsing sounder after a 10-second delay. The sounder may be silenced by pressing the **[RESET]** button. The LED will go off within 30 seconds after reset if the alarm or trouble is cleared. For Smoke-Detector Reset, see Alarm Outputs.

A fire condition that has not been restored will cause the zone number and description to scroll. To reset (acknowledge) the condition, enter a valid code, then press the **[RESET]** button. If Keypad Fire is programmed, pressing both the **[7F]** and **[*]** buttons at the same time will sound a fire panic alarm and display "*****FIRE*****" at the keypad. The Keypad Fire function is supplementary to the hardwired zones. **Note:** This feature shall not be considered a substitute for listed manual initiating devices.

Include Selective/Group Bypass In Conditional Closing/Status See Closing Report; Interior Zones by Area; Interior Normally Bypassed; Auto Interior Bypass

Removal of a programmed group of interior zones from the system will permit freedom of movement throughout the premises but still afford protection from intrusion through armed perimeter zones. Pressing the **[INTERIOR]** button prior to arming will select the Interior Zones, then arm to bypass. The next time the control panel is disarmed, all bypassed zones will automatically revert to non-bypassed (disarmed) zones. When the **[INTERIOR]** button is pressed, the "BYPASSED" reminder will come on.

The bypassed zones may be displayed on the keypad (see GEM-RP1CAe2 FUNCTION MODE).

If Interior Normally Bypassed is selected, all Interior Zones will always be inactive. The "BYPASSED" reminder will always display, indicating that only partial protection will be provided upon arming. To temporarily restore interior protection, press the **[INTERIOR]** button; the "BYPASSED" reminder will go out upon arming, denoting full protection, however Interior Zones will once again be bypassed the next time the panel is disarmed.

If "Auto Interior Bypass" is programmed, all Interior Zones will automatically provide protection if the Exit/Entry doors are opened during exit delay. (**Note:** Interior Normally Bypassed must be programmed.) If the **[INTERIOR]** button is pressed while armed, exit delay will restart and Exit/Entry doors may be opened to permit someone to exit (while others remain on premises) without causing an alarm.

Jumpers (Refer to Wiring Diagram for UL configuration)

JP1: Keypad Configuration Jumper (top-right corner, above micro shield) is installed across top and center pins for normal operation. When configuring GEM-RP1CAe2 keypads, move jumper across center and lower pins.

JP3: 2-Wire Fire jumpers. Select Zones 7 and/or 8 for use as either 2-Wire Fire Zones or Burglary Zones. **Note:** If customizing a single-area default program, Zone 8 is configured as a 2-Wire Fire Zone. In a two-area default program, Zones 7 and 8 are configured as 2-Wire Fire Zones common to both areas; be sure to move JP7 Zone-7 jumper to the 2-WF position (see Wiring Diagram).

GEM-RP1CAe2 Keypad Jumpers

Refer to label LA1374 on the circuit board fishpaper for jumper locations and a summary of settings.

JP1: Cut to enable Keypad Tamper.

W1 & W3: Cut both to disable touch pad backlighting.

W2: Cut to disable LCD backlighting.

GEM-RP2ASe2 Keypad Jumpers

Refer to label LA1390 on the circuit board fishpaper for jumper locations and a summary of settings. See Section 3: Configuring the GEM-RP2ASe2 Keypad for jumper selection.

Key Fob Transmitters

Aux. Output Chirp on Key-Fob Arming

Don't Clear Aux. Relay with Arm/Disarm

Aux. Output Chirp on Key-Fob Arming will cause a 1-second chirp to sound on arming and a 2-second chirp on disarming. Use the steady output of a siren driver. Do not use a voice siren driver.

Programming a "C as the Key-Fob Aux-1 or Aux-2 option will provide the ability to toggle the Aux. Relay on or off. If there is an Aux. Relay timeout programmed, it will follow this timeout unless toggled off by the key fob. To provide key-fob-only control, program no timeout. Program Don't Clear Aux. Relay with Arm/Disarm to prevent a disarm from resetting the Aux. Relay. Key-fob users can report openings and closings. Key fobs 1–8 report as Users 25–32, respectively.

Keypad Access see Access Control

Keypad Area Assignments

In multiple-area systems, assign an Area Number ("1" or "2") to each keypad. Note that each address comprises 2 nibbles; enter the Area Number in the right nibble.

Keypad Features

The following programmed system features will activate only if they have also been enabled at the keypad.

- ✓ Ambush
- ✓ Easy Arming
- ✓ Access Control
- ✓ Keypad (Police) Panic
- ✓ Keypad Auxiliary Panic
- ✓ Keypad Fire Panic

Keypad Panic See Panic Zone

Keypad Sounder on Alarm

If a programmed zone goes into alarm, the keypad sounder will activate and will remain activated until the **RESET** button is pressed or the system is disarmed.

Keypad Tamper See Tamper

Keyswitch Arming

The area will arm/disarm when the programmed zone is momentarily shorted (momentary keyswitch). To supervise the keyswitch, program the zone for Day Zone on Open.

Line-Reversal Module, M278

The Line-Reversal Module allows the panel to be monitored by a central station through leased lines. On alarm, the module reverses normal line-voltage polarity. For details, refer to the instructions furnished with the module.

Loop Response (750mS required for UL installations)

Loop response is the amount of time in milliseconds (mS) that a normally-closed circuit must remain open, or a normally-open circuit must remain closed, to trigger an alarm. The slower the loop response, the more immune the system will be to intermittents ("swingers"). Loop response times for Zones 1 through 8 are programmed into the control panel; Zones 9-16 with "Zone Doubling" enabled have loop responses the same as their respective 1-8 zones; those for Zones 9 through 32 loop responses are selected in the respective keypad configuration mode or expansion module jumper. (Refer to keypad instructions and EZM Installation Instructions.)

Selectable loop-response times for Zones 1–8 are:

750mS (.75 sec.): The slowest loop-response time, recommended for use with magnetic contacts, window foil, etc. Unless programmed otherwise, loop-response time will be 750mS for all zones.

50mS (.05 sec.): Used for momentary Panic Buttons and area-protection devices, such as photoelectric eyes, passive infrared sensors, floor mats, etc.

10mS (.01 sec.): An extremely fast loop response used primarily for window bugs.

Low Battery (Required for UL Mercantile installations)

A low-battery system trouble will annunciate at the keypad when the battery terminal voltage drops below normal. This condition may signal a local sounding device, report to a central station (program Panel Low Bat Report Code), or both. If a battery is installed and low terminal voltage is detected, a restore will not occur until the battery is recharged to its specified level and passes a dynamic test. The dynamic test may be initiated manually by pressing the **RESET** button, or it will be initiated automatically, every four hours, by the panel.

In wireless installations, when displaying rf transmitter status, a "LoBatt" indication denotes a low-battery condition at the transmitter.

Memory Failure

A User or Dealer Memory error will cause the sounder to pulse, the "SYS/TRBL" reminder to flash, and the display to read "E19-00 USER MEM ERROR" or "E20-00 DEALER MEM ERROR". Press the **RESET** button to silence the sounder ("SYSTEM READY" will display, along with the "SYS/TRBL" reminder). Activate RESET SYSTEM TROUBLE to manually reset the system trouble. A Memory Failure can be programmed to activate an alarm output and/or report using its associated system Report Code.



Never Arm (Do not use for primary Burglary protection)

A zone programmed as “Never Arm” cannot go into alarm. If tripped, it will display at the keypad when the DISPLAY STATUS function is selected. A chime will sound at the keypad while armed or disarmed if Chime is also programmed for that zone, and enabled by entering a valid time. This feature is suggested for use as a garage-door or driveway monitor, or similar application.

No EOL Resistor

Program for any zone not wired with a 2200W end-of-line resistor (Napco Part No. EOL2.2K). This will disable any zone-short indication (if programmed, “Day Zone Short” is disabled). If not programmed, an end-of-line resistor must be installed. Note: This selection is automatically disabled for zones selected as Fire.

Number of Rings Before Pickup See Callback-Method Download







One-Button Arming See Easy Arming

Opening Report; Opening Report Only After Alarm Report (Do not program for UL installations)

Opening and closing reports are generally used in commercial installations. On disarming, the communicator can send an Opening Code for Users 1–32 (Opening Report), or it may transmit only when the control panel is disarmed after an alarm has been reported (Opening Report Only After Alarm Report). (**Note:** Key Fobs 1–8 report as Users 25–32.) Subscriber Identification Numbers and Opening Codes must be entered for either opening report.

Program Opening Report Only After Alarm Report to report only when disarming after an alarm report. This feature may be used by the central station to verify that the subscriber has responded and disarmed the panel. If “Opening Report Only After Alarm Report” is selected, also select “Opening Report” for each user.

Panic Zone; Keypad Aux Panic; Keypad (Police) Panic; Keypad Fire Panic See Fire; Remote Panic

The Panic Zone is always a 24-Hour Zone. Each keypad is individually selectable for keypad panics (see Keypad Features). If “Keypad Panic” is programmed for a keypad, police panic is activated by simultaneously pressing the  and  buttons. If “Keypad Aux.” is programmed, pressing the  and  buttons simultaneously will trip an auxiliary emergency alarm. If “Keypad Fire” is programmed, pressing the  and  buttons at the same time will activate fire panic.

A remote panic button may be connected to a GEM-RP2ASe2 Keypad. Splice the two white wires from the keypad to a normally-open momentary-contact pushbutton. Additional panic buttons may be wired in parallel with the first. If remote panic will not be used, insulate both white wires, as a short across them will cause a panic alarm. (In UL installations, remote-panic buttons must be located within 3 feet of the keypad, with no intervening walls or barriers.)

Power-Up Delay

If programmed, power-up will be delayed for 5 minutes to allow devices such as PIRs time to stabilize (warm up). This will prevent false alarms when ac power is restored after a long power outage and the backup battery is discharged.

Pre-Alarm Warning (Not for UL applications)

Programmable by zone, this feature will cause an alarm to sound only at the keypad for the duration of the programmed abort delay (see Abort Delay; Time Selection). After the delay has elapsed, the alarm output will activate and a report will be sent. **Note:** If no Abort Delay time is programmed, Pre-Alarm Warning time will be 10 seconds.

Pre-Dial Delay

A Pre-Dial Delay may be used whenever a delay is required before dialing. It may be required when programming Dial-Tone Detection, which causes the communicator to wait before it attempts to detect a dial tone (see Dial-Tone Detection). Certain telephone exchanges send a nonstandard dial tone that the communicator may not be able to detect. With these nonstandard exchanges, it is possible to program Pre-Dial Delay rather than Dial-Tone Detection. This will cause the communicator to wait for a predetermined period of time before dialing rather than look for a nonstandard dial tone.

Contact the telephone-equipment supplier to find out how long a delay is required before dialing. Select “Pre-Dial Delay” by programming one “D” for each 4-second delay required immediately before the telephone number. **Note:** In UL installations, do not program more than one “D” before the telephone number.

See Backup Report on Telco 2; Report Telco 3 (Double or Split Reporting). Also see Access Number for Outside Line; Telephone Numbers.

Priority Area Arming



Prevents area arming if the alternate Priority Area has not yet been armed.

Priority Zone (Required for all zones in UL installations.)

A zone that will prevent arming if in trouble. If an attempt is made to arm, the sounder will come on and “ZONES NOT NORMAL / CAN'T ARM” will be displayed for 4 seconds. The keypad may be reset by simply pressing the  button. The problem on a Priority Zone must be corrected before the panel can be armed. Any zone may be selected as a Priority Zone. A zone in trouble that is neither a Priority Zone nor an Auto-Bypass Zone will cause an alarm on arming.



Priority Zone with Bypass

A Priority Zone that will permit arming if the priority condition is bypassed. If the system is so programmed, the zone will auto-bypass and (optional) the condition will be reported to a central station. As above, if an attempt is made to arm, the sounder will come on and "ZONES NOT NORMAL / CAN'T ARM" will be displayed. To reset the keypad, press the  button; the display will read "ZONE FAULTS". To arm the panel, press the  button, then enter the User Code. Any zone not selected as a Priority Zone may be programmed as a Priority Zone with Bypass.

Pulse Burglary Output See Alarm Outputs

Receiver Format

The communicator can be programmed to transmit to any standard central-station receiver. A receiver format must be entered for each telephone number used, but a different format may be assigned to each. Refer to Backup Report on Telco 2 and Report Telco 3 to determine whether or not Telephones 2 and/or 3 will be programmed. Call the central station for each telephone number used to confirm the type of receiver in use. Select the receiver format entry for each telephone number from the following table.

ENTRY	RECEIVER FORMAT	DATA FREQ. (Hz)	DUTY CYCLE (ON/OFF)	INTERDIGIT TIME
blank (*)	Ademco, Silent Knight Slow	1900	60/40mS	600mS
1	Sescoa, Vertex, DCI, Franklin Fast	1800	30/20	800
2	Radionics Fast	1850	13/12	400
3	Silent Knight Fast	1900	40/30	560
4	Radionics, DCI, Franklin Slow	1800	60/40	600
5	Universal Hi-Speed	1850	30/20	350
8	Radionics BFSK	Modem formats		
9	4/3/1*			
A	Radionics Modem 2*			
B	SIA*			
C	Point ID*			
D	Express (touch-tone 4/2 format)			

*These formats do not use programmable codes, but Event ID Codes to identify the type of zone as follows:

- 1 – Fire
- 2 – Panic
- 3 – Burglary
- 4 – Holdup
- 7 – Gas Alarm
- 8 – Heat Alarm
- A – Auxiliary Alarm (keypad displays "0")
- B – 24-Hour Auxiliary Alarm

Relay Control (Optional External Relays)

In addition to the three relay outputs (Bell, PGM1 and PGM2) provided on the motherboard, up to 8 external relays can be controlled from the keypad through the use of the RM3008 Relay Module. The RM3008 is designed for external remote mounting. One module is needed for the GEM-P1632 Control Panel. Sixteen relay events (Address 0750-0829) can be assigned to any of the 8 available external relays from Relay Module RM3008. Multiple relay events can drive the same External Relay.

Relay Follows Zone

External Relays can be programmed to follow a zone. If values are entered in Time locations, the relay will time out after the programmed time.

Relay Outputs See Alarm Outputs

Remote Panic See Panic Zone

Report Telco 1; Report Telco 3 (Double or Split Reporting)

Alarms, alarm restores, troubles and trouble restores may be selected individually for each zone. Violation of a zone selected to report will communicate the code(s) selected for that zone to the central station.

Normally, Report Telco 1 is used to report to the central station. Report Telco 3 is used when certain zones will report to a different receiver (split reporting); Report Telco 1 and Report Telco 3 are both used on the same zone to report to two receivers successively (Double Reporting). (Double Reporting requires a successful report to Telco 1 before reporting to Telco 3.) Also see Backup Report on Telco 2.

Reset Day Zone with Arm/Disarm Only See Day Zone

Reset Relay See Alarm Outputs

Silence All Outputs During Audio Session See Veri-Phone

Single-Digit Format See Data Format

Smoke Detectors

Connect smoke detectors as shown in the diagrams. The "Fire Power" (Terminal 25) is used to reset the smoke detectors.

Two-Wire Smoke Detectors

Two-wire smoke detectors may only be used only on Zones 7 and 8. Up to 10 compatible 2-wire smoke detectors may be wired to each zone. In Residential applications, program Pulse Burg Output. Program Disable Fire Reset in the applicable area(s).

Zones 7 and 8 have been designed so they can be easily configured as 2-wire smoke detector zones by means of jumpers (JP3) located above Terminal 21.

1. Program Zones 7 and/or 8 for 2-Wire Smoke Detectors and Fire.
2. If Zone 7 is selected as a 2-Wire Fire Zone, move the left jumper on JP3 from the top two pins (BURG) to the bottom two pins (2WF).
3. Similarly, if Zone 8 is selected as a 2-Wire Fire Zone, move the right jumper on JP3 from the top two pins (BURG) to the bottom two pins (2WF).
4. Connect 2-wire smoke detectors to Zones 7 and/or 8 as shown in the GEM-P1632 Installation Instructions (WI808).

Four-Wire Smokes

If installing 4-wire smokes, subtract smoke-detector alarm current from available standby current. See COMPATIBLE UL-LISTED DEVICES.

Wire 4-wire smokes as shown in the GEM-P1632 Installation Instructions (WI808). Program each zone for Fire. Also program zones for Pulse Burglary Output, and Disable Fire Reset in the applicable area(s) (System Options). If they are of the self-resetting type, 4-wire smokes may be powered from Terminals 25 and 6.



Start Exit Delay After Ringback

When a closing report is successfully received, the central station will acknowledge by returning a kiss-off signal. When the kiss-off is received by the communicator, a 2-second ringback tone will sound at the keypad. Start Exit Delay After Ringback will cause the exit delay to start after the ringback sounds. If this option is chosen and no ringback sounds shortly after the control panel is armed, exit delay will not start and opening the exit/entry door will cause an instant alarm. To manually start the exit delay, select the START EXIT TIME function, then press the  button to execute.

Note: (1) If this feature is selected, Exit/Entry Follower Zones will not arm until either a ringback sounds or the START EXIT TIME function is used. (2) If communicator, telephone lines or central-station receiver is out of service, the system will be armed without communication capability.

Status Report See Closing Report

Subscriber Identification Numbers

If reporting openings and/or closings, program Subscriber Opening/Closing Identification Numbers for each area for each telephone number used. If reporting events, program Subscriber ID Numbers for each area for each telephone number used. Subscriber ID numbers must be programmed for each area and telephone number, even if all are the same. Start with the left-most location.

Sum Check See Data Format

Suppress “BYPASSED” Reminder When Armed (Must be enabled in all UL systems)

Program to inhibit the LCD “BYPASSED” display while armed.

Swinger Shutdown (Do not program for UL Installations)



Program for zones with Auto-Reset to only reset twice (3 alarms) until rearmed to prevent “swingers” (intermittents) from causing repeated false alarms. See Auto-Reset. The Swinger-Shutdown feature is programmable by zone, but is not applicable to Ambush.

System Troubles (Global and Area)

System troubles may be programmed to report to any telephone number and/or activate any output. Also program Subscriber ID Numbers, Telephone Numbers, and Report Codes for each system trouble.

Note: RF TROUBLE will report for RF Low Battery, RF Supervisory Failure or GEM-DT Self-Test Failure.

Tamper; EZM Tamper; Keypad Tamper; RF Tamper

Removing the cover of an expansion zone module will cause the sounder to pulse and the “SYS/TRBL” reminder to flash. The keypad will display “E13-NN BURG EZM TAMPER”, where “NN” denotes the module number. Press the  button to silence the sounder (“SYSTEM READY” will display). Correct the problem, then select RESET SYSTEM TBL to manually reset the system trouble display. Removing a keypad from the wall causes a similar system trouble indication. The keypad will display “E11-NN BURG KPD TAMPER”, where “NN” denotes the keypad number. Press the  button to silence the sounder (“SYSTEM READY” will display). To manually reset the system trouble, correct the problem then select RESET SYSTEM TBL.

Note: If either of the tamper conditions is not corrected within 5 minutes, the system trouble will again display at the keypad. A Tamper condition can be programmed to activate the burglary output and/or report using its associated system Report Code. In wireless installations, when displaying rf transmitter status, a “Tamper” indication denotes that the transmitter case is open.

Telco Fail See Enable Line-Fault Test

Telco Line Test Delay See Enable Line-Fault Test; Time Selection

Telephone Numbers

To report to a central station, Telephone Number 1 (Address 0172-0191) must be programmed. Telephone Number 2 (address 0194-0213) is programmed for Backup Reporting (Address 0394); Telephone Number 3 is programmed for Double or Split Reporting by selecting “Report Event Telco 3” and “Report Restore Telco 3” in SYSTEM OPTIONS and ZONE OPTIONS.

Private telephone systems may require a Dial-Tone Detection “E” or Pre-Dial Delay “D”, followed by an access number to obtain an outside line. (See Access Number for Outside Line.)

It should be noted here that the telephone number need not actually start in the first location shown, and may not end in the last. Extra locations have been provided to allow for one or more prefix digits: a Pre-Dial Delay “D” or a Dial-Tone Detection “E”. What is important is that the telephone number, with its associated Pre-Dial Delay, Access Number, and Dial-Tone Detection, be wholly contained within that group of locations, and that they be in their proper sequence.

Test Timer; Cancel Next Test Timer Report on Any Report

The test timer schedule is programmed using Napco's PCD3000 Quickloader Software. If "Test Timer" (Address 0460-0469) is programmed, an automatic test report will be transmitted to the central station on the scheduled day(s) at the scheduled time. (UL installations require a report at least every 24 hours.) To report test timer, select Report Test Timer and program a report code. Program the Test Timer event schedule and reporting time. If "Cancel Next Test Timer Report on Any Report" (Address 0394) is programmed, any report will cause the next test-timer transmission to be aborted, however subsequent test-timer transmissions will report as scheduled. Do not program this feature in UL installations.

Timeout

Specifies the length of time that an alarm, alert, or delay will remain active. See Time Selection.

Time Selection

The following times are programmable:

TIME(1)	UNITS	MAX. PROG. TIME	ADDRESS
PGM2 OUTPUT TIMEOUT	MIN.	UNTIMED(2)	0710
PGM2 OUTPUT ACCESS CONTROL TIME	SEC.	4 MIN, 15 SEC (255 SEC)	0711
BURGLARY OUTPUT	MIN.	UNTIMED(1)(2)	0712
PULSE-BURG OUTPUT	MIN.	UNTIMED(1)(2)	0713
PGM1 OUTPUT	MIN.	UNTIMED(2)	0714
ABORT DELAY	SEC.	4 MIN, 15 SEC (255 SEC)(3)	0715
CHIME TIME	SEC.	63.25 SEC (255 QTR-SEC)(3)	0716
AC-FAIL REPORT DELAY	10 MIN.	42 HR, 30 MIN (2550 MIN)	0717
EXIT DELAY	SEC.	4 MIN, 15 SEC (255 SEC)(4)	0000
ENTRY DELAY 1	SEC.	4 MIN, 15 SEC (255 SEC)(4)	0001
ENTRY DELAY 2	SEC.	4 MIN, 15 SEC (255 SEC)(4)	0002

NOT

E S :

(1) The output used for Burglary must be at least 4 minutes in Residential UL installations, 15 minutes in Commercial UL installations. (2) If both locations are left blank, this feature will remain active until the system is disarmed. When both locations are programmed "F", maximum time will be 4 hours, 15 minutes (255 minutes). (3) If both locations are left blank, this feature will not activate (timeout = 0). (4) In UL installations: Maximum Exit Delay = 60 sec; Maximum Entry Delay = 45 sec. (5) If programming locations are left blank, delay will default to 10 sec. (6) Time in units of disarmed hours (accumulated between armed periods). Any timeout up to those shown in the foregoing table may be programmed. Note that each of the above times is programmed in two locations. The first location has an assigned time factor of 16, the second a time factor of 1.

1st BOX	2nd BOX
tx16	tx1

Time t:	0	1	2	3	4	5	6	7	8	9	10	11	12	13	14	15
Entry	blank (*)	1	2	3	4	5	6	7	8	9	0	B	C	D	E	F

Note: If both locations are left blank, refer to the notes in the Time Selection table for feature timeout.

To select a time up to 15 seconds, 15 minutes, 15 hours, or 15 days, program the respective entry into the second box only; do not program the first box. To select a time greater than 15 seconds, 15 minutes, 15 hours or 15 days, program both boxes as follows:

1. For the feature selected, choose an appropriate time in units shown (all seconds, minutes, hours, or days — not minutes and seconds, etc.).
2. Divide the time chosen by 16. Enter the quotient in the 1st BOX and the remainder in the 2nd BOX.
3. Check entries by adding the contents of the 2nd BOX to 16 times the contents of the 1st BOX. (Remember that a "zero" entry represents 10.)

Example. Program Entry Delay 1 for 1 minutes.

1. Entry Delay 1 is in units of seconds, thus delay time is 90 seconds.
2. Divide by 16: $90/16 = 5$ (quotient) + 10 (remainder). Enter the quotient in the 1st BOX and the remainder in the 2nd BOX:

1st BOX	2nd BOX
5	0
quotient	remainder ("0" for 10)

GLOSSARY



3. Check entries (remember, a "0" entry = 10): $(16 \times 5) + 10 = 90$.

Touch-tone Dialing Only; TouchTone Dialing with Rotary Backup

Select "TouchTone Dialing Only" (Address 0394) if the subscriber has TouchTone service. TouchTone dialing is faster than rotary dialing, but not always as reliable.

For the communicator to use TouchTone on all dial attempts, program TouchTone Dialing Only. To use TouchTone on the first attempt with subsequent Rotary dial, program TouchTone Dialing with Rotary Backup. TouchTone Dialing Only will override TouchTone Dialing with Rotary Backup if both are selected. Note that if Backup Reporting is also selected, the communicator will alternate between TouchTone and rotary dial to reach Telephone 1, then Telephone 2. See Backup Report on Telco 2.

Trouble

An abnormal zone condition (a break in a normally-closed loop; a short on a normally-open loop; or either on an end-of-line-resistor supervised loop) when disarmed.

Trouble on a Burglary Zone is automatically displayed at the keypad unless Disable Auto Status is programmed. If a Burglary Zone is in trouble, it will go into alarm about 10 seconds after arming. However, if Auto Bypass is programmed, the keypad will beep upon arming (does not apply to selective- or group-bypassed zones).

Trouble (open and/or short circuit) on a Day Zone is indicated by a pulsing sounder; display the Day Zone(s) in trouble on the LCD. Keypad indications are reset by the **RESET** button unless Reset Day Zone With Arm/Disarm is selected.

Trouble on a Fire Zone will be indicated by the "FIRE/TRBL" reminder and the sounder. An open circuit (trouble) will cause a flashing "FIRE" display and a pulsing sounder after a 15-second delay. (A short circuit will cause an alarm condition: steady-on "FIRE" display and pulsing sounder.) The **RESET** button will silence the sounder. Clear the trouble, then press the **RESET** button once again. The keypad will reset after a brief delay.

Trouble on Open; Trouble on Short; Trouble on Night Open (Not for UL installations)

Trouble on Open will identify an open circuit on a loop as a trouble. Trouble on Short will identify a short circuit as a trouble. Trouble on Night Open, which will identify an open circuit on a normally-closed zone while armed as a trouble condition (not an alarm), is intended for use with a Napco Monitor-Series dual-technology sensor. While there will be no indication at the keypad, any of these trouble conditions can be reported if Report Trouble is programmed as well. See Sensor Watch.

Trouble/Trouble Restore Telco 1/Telco 3 See Report Telco 1/Telco 3

Trouble/Trouble Restore Telco 2 See Backup Report on Telco 2

Two-Digit Format See Data Format

Two-Wire Smoke Detectors See Smoke Detectors

User Codes/Area 1 & 2 Options; User Closing and Opening Reports by Telephone Numbers; Enable User Code by Area

Up to 32 six-digit User Codes are programmable, each with its dedicated Area 1 & Area 2 Options. (Disabled, Arm/Disarm, Arm Only, Service, Access and User Program.) Refer to Easy Menu Driven Program Mode. If reporting to a central station, program User Closing and Opening Reports by Telephone Numbers (Address 0440-0459). **Note:** An Ambush Code should not contain digits used as the first two digits of any user code.

Veri-Phone™; Silence All Outputs During Audio Session; Veri-Phone Zones Priority Over Alarms; Veri-Phone Zones Trip PGM2 Output

If Silence All Outputs During Audio Session is selected, all output relays will turn off whenever an active low is applied to control-panel Lug E19 (Listen In). Connect Veri-Phone Terminal 16 (INHO) to Lug E19. **Note:** Do not program Keypad Sounder on Alarm for Listen-In Zones.

If "Veri-Phone Zones Priority Over Alarms" (Address 0722) is programmed and an active low is applied to the panel's Listen-In Lug (E19), any subsequent alarm reports (except fire alarms) generated during an audio session will be delayed until the end of the session. (Whenever a listen-in session is in progress, the Veri-Phone will output an active low at its INHO Terminal (16) and Lug E1.) Program "Veri-Phone Zones Trip PGM2 Output" (Address 0722) to have selectable Listen-In Zones. Connect Veri-Phone Terminal 13 (TRIGL) to control-panel Terminal 8 (PGM2). Program the zone or event for PGM2. Do not use the PGM2 for any other purpose.

Watch Mode (by Area) See Day Zone

Zone ANDing, Groups 1–2 (Not for UL installations); Enable Local Alarm on First Zone “AND” Trip (Not for UL installations)

Up to two groups of at least two zones each can be “AND”ed (Address 0534-0537, 0589-0592, 0644-0647, 0699-0702), wherein the system will go into alarm only if any two zones of the group are tripped within a prescribed time. This feature is designed to afford redundant protection for devices, such as glass break detectors, PIRs, etc., that may show a tendency to false under certain conditions. Program each group for any number of Zones 1–32. All zones in any group must be within the same area. Do not mix 24-Hour Zones and non-24-Hour Zones within the same group. Do not include a Panic Zone as part of any group.

Note: Any zone that is bypassed or goes into swinger shutdown will automatically disable Zone Anding for the entire group.

If “Enable Local Alarm on First ZoneAND Trip” (Address 0719) is programmed, a trip on any zone of the group will cause an alarm indication at the keypad only; there will be no communication to the central station.

Zone Area 1–Zone Area 2 See Areas

Zone Number on Pulse Alarm See Data Formats: Two-Digit Format

Zone Type See Data Formats: Modem Formats

2-Wire, 4-Wire Smoke Detectors See Smoke Detectors

4-Wire Bus Failure See Bus Failure

24-Hour Zone

A zone selected for “24-Hour Zone” (Address 0499, 0554, 0609, 0664) that provides protection at all times, whether or not the system is armed. If “Alarm Output”, “Pulsed Alarm Output”, “PGM1 Output”, “PGM2 Output” and “Keypad Sounder on Alarm” are **not** selected, then the zone is programmed for silent alarm. In this case, the green LED on the keypad will go out if the zone is tripped.

Note: Do not program a Day Zone as a 24-Hour Zone.



KEYPAD PROGRAMMING MODES

KEYPAD PROGRAMMING MODES

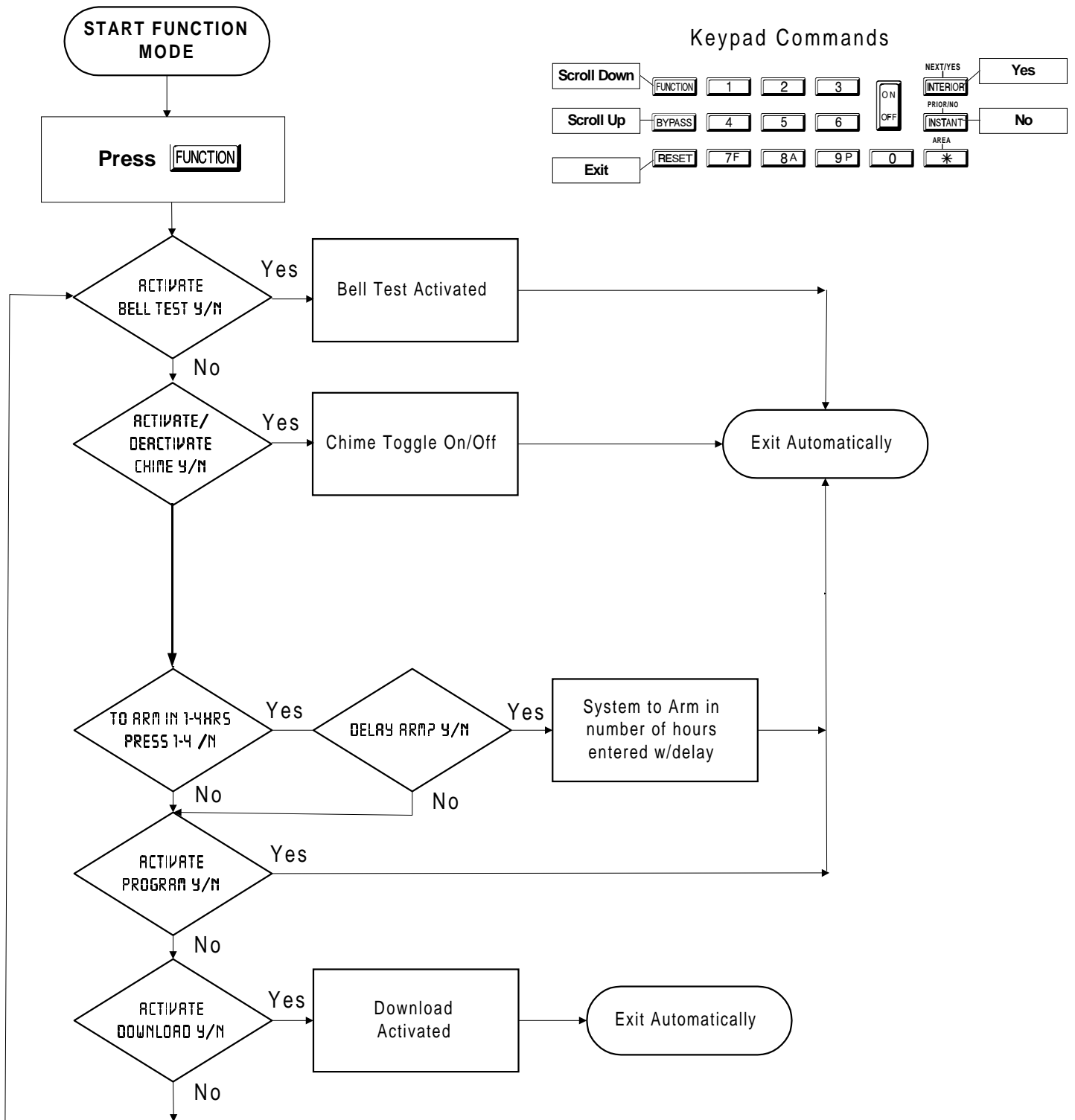

Keypad Commands

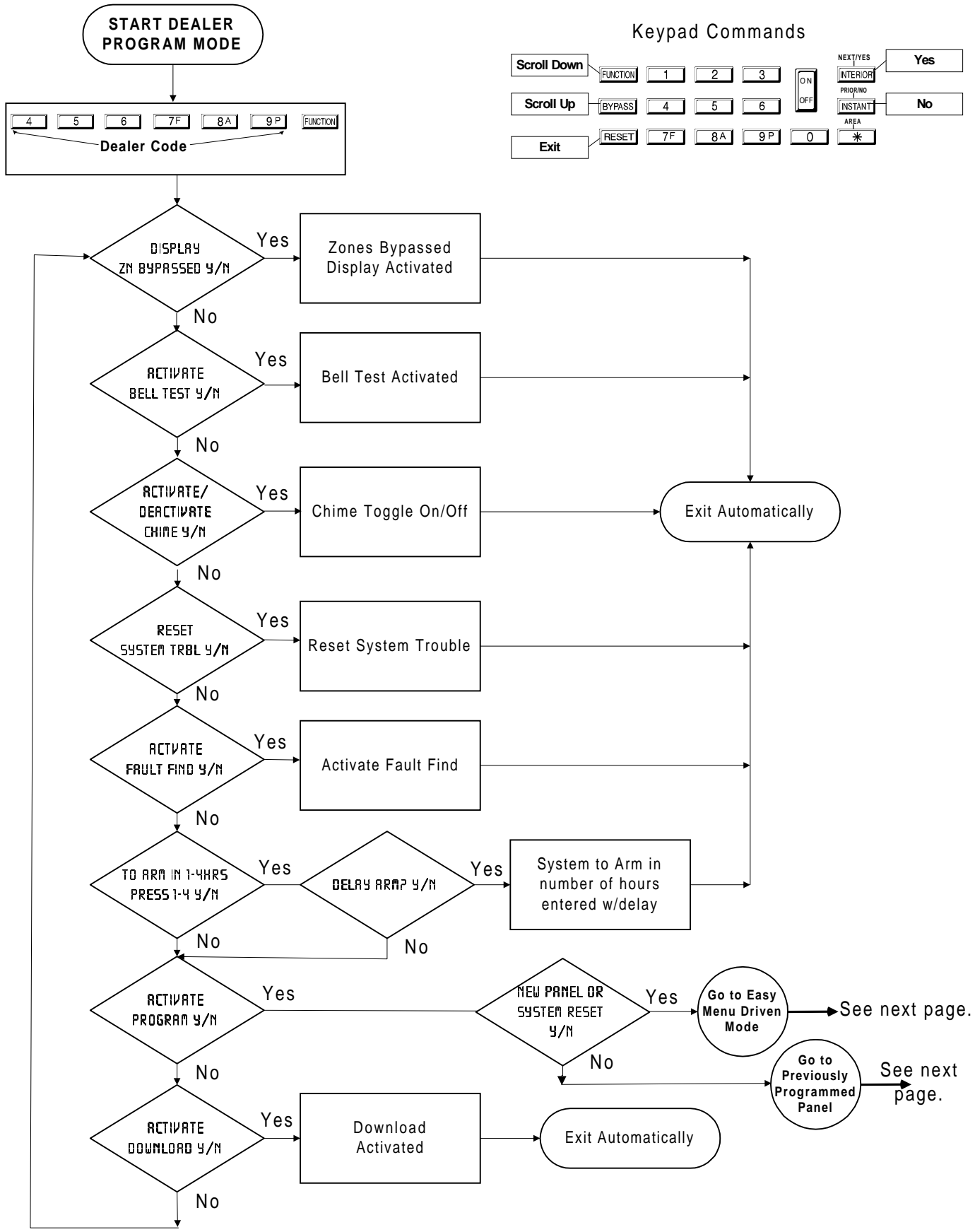
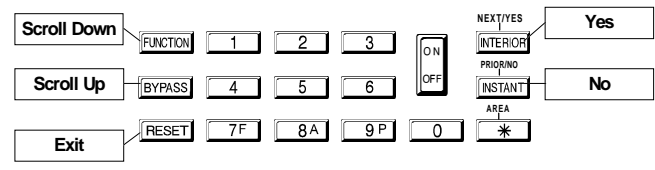

KEYPAD PROGRAMMING MODES

Keypad Commands

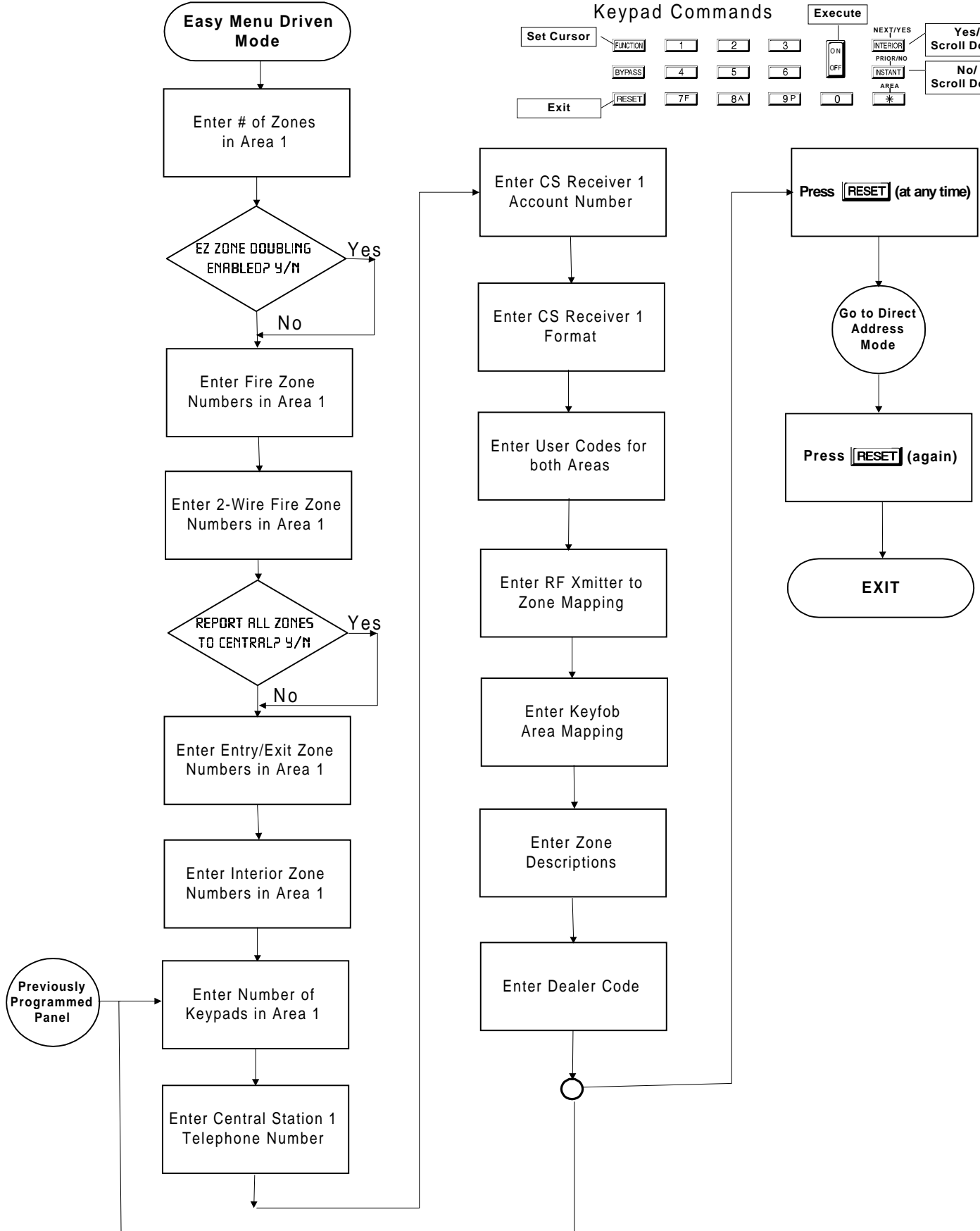
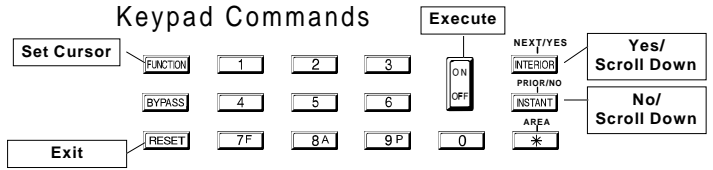

Keypad Commands

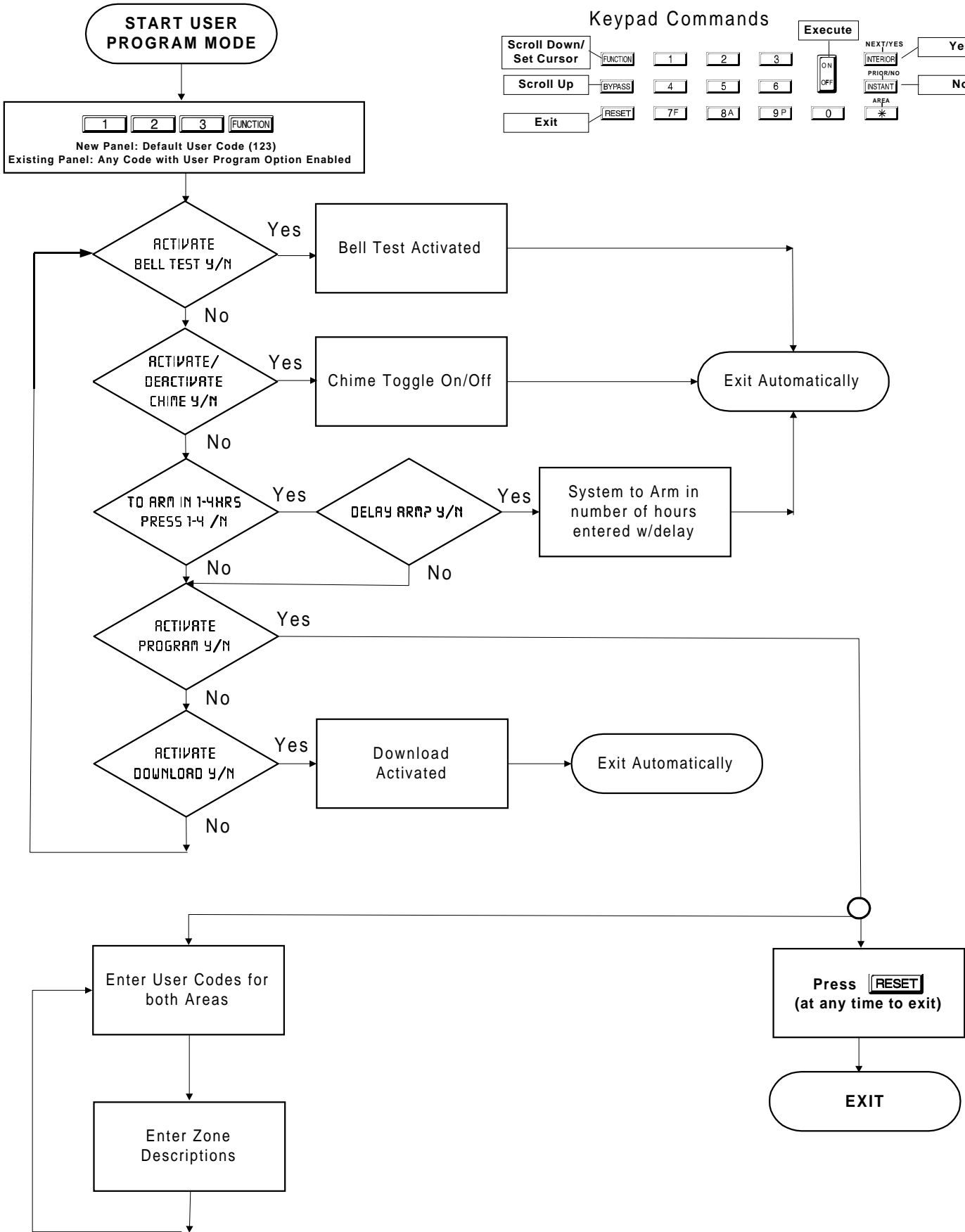
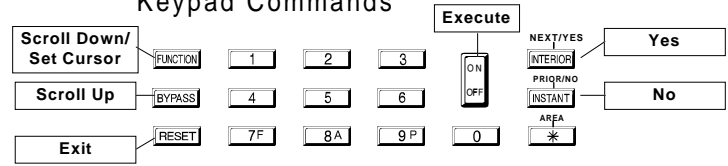

GEM-P1632 WIRING DIAGRAM

NAPCO SECURITY SYSTEMS, INC.
 AMITYVILLE, N.Y. 11701

GEM-P1632 WIRING DIAGRAM

(REFER TO OPERATION AND INSTALLATION INSTRUCTIONS W808)

RESIDENTIAL AND COMMERCIAL BURGLARY **

16.5V TRANSFORMER	STANDBY BATTERY	COMBINED STANDBY CURRENT	ALARM CURRENT	STANDBY CURRENT TIME
40VA/50VA	7AH	120mA	520mA(1)	24 HOURS
40VA/50VA*	2-7AH	360mA	280mA(1)	24 HOURS
20VA*	7AH	120mA	360mA(1)	24 HOURS
20VA*	2-7AH	360mA	120mA(1)	24 HOURS

RESIDENTIAL FIRE

16.5V TRANSFORMER	STANDBY BATTERY	COMBINED STANDBY CURRENT	ALARM CURRENT	STANDBY CURRENT TIME
40VA/50VA	7AH	120mA	520mA(1)	24 HOURS
40VA/50VA*	2-7AH	360mA	280mA(1)	24 HOURS
20VA*	7AH	120mA	360mA(1)	24 HOURS
20VA*	2-7AH	360mA	120mA(1)	24 HOURS

(1) ALARM CURRENT CAN BE INCREASED BY REDUCING STANDBY CURRENT BY THE SAME AMOUNT.

* NOT PRESENTLY EVALUATED BY U.L.
 ** COMMERCIAL BURGLARY IS NOT PRESENTLY EVALUATED BY U.L.

This equipment should be installed in accordance with Chapter 2 of the National Fire Alarm Code, ANSI/NFPA 72-1996 (National Fire Protection Association Batterymarch Park, Quincy, MA 02269), and local codes. Information describing proper installation, operation, testing, maintenance, evacuation planning, and repair service is to be provided with this equipment. UL Listed Limited Energy Cable is required.

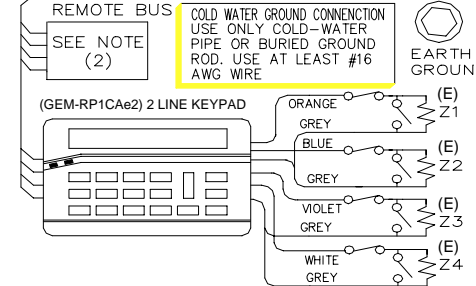
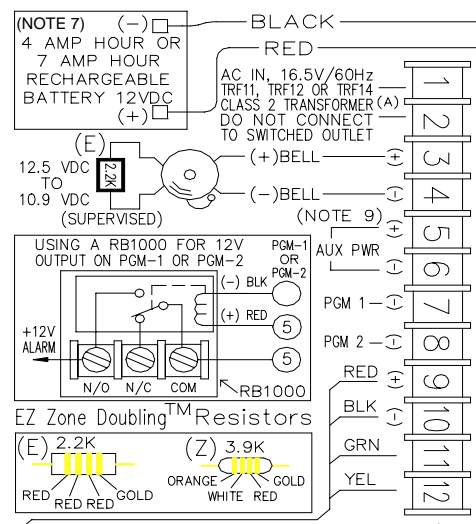

THIS UNIT INCLUDES AN ALARM VERIFICATION FEATURE THAT WILL RESULT IN A DELAY OF THE SYSTEM ALARM SIGNAL FROM THE INDICATED CIRCUITS. THE TOTAL DELAY (CONTROL UNIT PLUS SMOKE DETECTORS) SHALL NOT EXCEED 60 SECONDS. NO OTHER SMOKE DETECTORS SHALL BE CONNECTED TO THESE CIRCUITS UNLESS APPROVED BY THE LOCAL AUTHORITY HAVING JURISDICTION.

CIRCUIT CONTROL UNIT SMOKE DETECTORS ZONES DELAY-SEC.

MODEL	DELAY-SEC.
(E)	30
(Z)	60

THE DELAY (POWER UP) (STARTUP) TIME MARKED ON THE INSTALLATION WIRING DIAGRAM OF THE SMOKE DETECTOR OR ON THE INSTALLED SMOKE DETECTOR(S) IS TO BE USED.

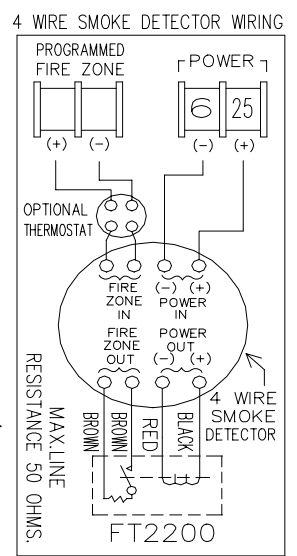
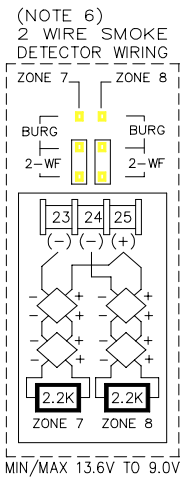
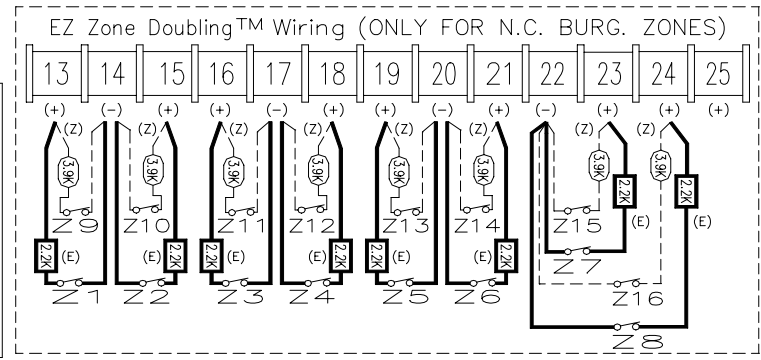
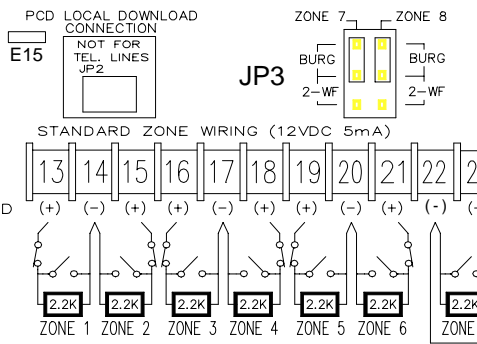

- NOTES:**
- 1.) ALARM CURRENT CAN BE INCREASED BY REDUCING STANDBY CURRENT BY THE SAME AMOUNT.
 - 2.) THE FOLLOWING DEVICES MAY BE PLACE ON THE REMOTE BUS: GEM-RP1CAe2, GEM-RP2ASe2, GEM-EZM816, GEM-X10, GEM-RECv8, GEM-RECv16, RM3008, GEM-EVA1 AND WIZARD2.
 - 3.) REFER TO W808 FOR U.L. LISTINGS.
 - 4.) COMBINED STANDBY CURRENT = KEYPAD CURRENT + AUX CURRENT + FIRE POWER + PGM1 AND PGM2 CURRENT.
 - 5.) UNIT INTENDED TO BE MOUNTED VERTICAL ON WALL
 - 6.) REFER TO W808 FOR COMPATIBLE TWO WIRE SMOKE DETECTORS. DO NOT MIX DIFFERENT MODELS.
 - 7.) RECOMMENDED BATTERIES YUASA NP4-12 OR NP7-12. BATTERY SHOULD BE REPLACED EVERY 5 YEARS.
 - 8.) THIS PANEL SHALL BE CHECKED BY A QUALIFIED TECHNICIAN AT LEAST ONCE EVERY 3 YEARS.
 - 9.) AUX. POWER AND FIRE POWER VOLTAGE RATING: 12.5 VDC TO 11.7 VDC.
 - 10.) A.C MUST BE DISCONNECTED WHEN PERFORMING WEEKLY TESTS.
 - 11.) THIS PANEL ONLY SUPPORTS ONE SMOKE DETECTOR IN ALARM FOR EACH ZONE.

LA1469B